

3-21-2013

# File Carving and Malware Identification Algorithms Applied to Firmware Reverse Engineering

Karl A. Sickendick

Follow this and additional works at: <https://scholar.afit.edu/etd>

Part of the [Hardware Systems Commons](#)

## Recommended Citation

Sickendick, Karl A., "File Carving and Malware Identification Algorithms Applied to Firmware Reverse Engineering" (2013). *Theses and Dissertations*. 904.

<https://scholar.afit.edu/etd/904>

This Thesis is brought to you for free and open access by the Student Graduate Works at AFIT Scholar. It has been accepted for inclusion in Theses and Dissertations by an authorized administrator of AFIT Scholar. For more information, please contact [richard.mansfield@afit.edu](mailto:richard.mansfield@afit.edu).



**FILE CARVING AND MALWARE IDENTIFICATION ALGORITHMS APPLIED  
TO FIRMWARE REVERSE ENGINEERING**

THESIS

Karl A. Sickendick, Captain, USAF

AFIT-ENG-13-M-46

**DEPARTMENT OF THE AIR FORCE  
AIR UNIVERSITY**

***AIR FORCE INSTITUTE OF TECHNOLOGY***

**Wright-Patterson Air Force Base, Ohio**

**DISTRIBUTION STATEMENT A.  
APPROVED FOR PUBLIC RELEASE; DISTRIBUTION UNLIMITED**

The views expressed in this thesis are those of the author and do not reflect the official policy or position of the United States Air Force, the Department of Defense, or the United States Government.

This material is declared a work of the U.S. Government and is not subject to copyright protection in the United States.

AFIT-ENG-13-M-46

FILE CARVING AND MALWARE IDENTIFICATION ALGORITHMS APPLIED TO  
FIRMWARE REVERSE ENGINEERING

THESIS

Presented to the Faculty  
Department of Electrical and Computer Engineering  
Graduate School of Engineering and Management  
Air Force Institute of Technology  
Air University  
Air Education and Training Command  
in Partial Fulfillment of the Requirements for the  
Degree of Master of Science in Computer Science

Karl A. Sickendick, B.S.E.E.

Captain, USAF

March 2013

**DISTRIBUTION STATEMENT A.**  
**APPROVED FOR PUBLIC RELEASE; DISTRIBUTION UNLIMITED**

FILE CARVING AND MALWARE IDENTIFICATION ALGORITHMS APPLIED TO  
FIRMWARE REVERSE ENGINEERING

Karl A. Sickendick, B.S.E.E.  
Captain, USAF

Approved:

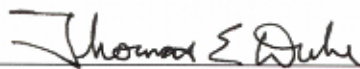
  
\_\_\_\_\_  
Maj Thomas E. Dube, PhD (Chairman)

26 FEB 13  
Date

  
\_\_\_\_\_  
Maj Jonathan W. Butts, PhD (Member)

4 Mar 13  
Date

  
\_\_\_\_\_  
Barry E. Mullins, PhD (Member)

22 Feb 13  
Date

## Abstract

Modern society depends on critical infrastructure (CI) managed by Programmable Logic Controllers (PLCs). PLCs depend on firmware, though firmware security vulnerabilities and contents remain largely unexplored. Attackers are acquiring the knowledge required to construct and install malicious firmware on CI. To the defender, firmware reverse engineering is a critical, but tedious, process.

This thesis applies machine learning algorithms, from the file carving and malware identification fields, to firmware reverse engineering, then characterizes the algorithms' performance. This research describes a process to speed and simplify PLC firmware analysis, and implements that process with the cross-platform *Firmware Disassembly System*. The system partitions a firmware into segments, labels each segment with a file type, determines the target architecture of code segments, then disassembles and performs rudimentary analysis on the code segments. This research characterizes the performance of file carving algorithms applied to the file type identification problem, and of malware identification algorithms applied to the architecture identification problem.

This research discusses the system's accuracy on a set of pseudo-firmwares. Of the algorithms it considers, the combination of a byte-frequency file carving algorithm and a support vector machine (SVM) algorithm using information gain (IG) for feature selection achieve the best performance. That combination correctly identifies the file types of 57.4% of non-code bytes, and the architectures of 85.3% of code bytes.

Finally, the system performs opcode frequency analysis on disassembly results. This research analyzes the opcode frequencies of four common PLC processor architectures. Opcode frequency analysis provides analysts a measure of disassembly correctness. This research applies the *Firmware Disassembly System* to several real-world firmwares, and discusses the contents.

## Table of Contents

|   | Page |
|---|------|
| Abstract . . . . .                                      | iv   |
| Table of Contents . . . . .                             | v    |
| List of Figures . . . . .                               | vii  |
| List of Tables . . . . .                                | viii |
| List of Acronyms . . . . .                              | x    |
| 1 Introduction . . . . .                                | 1    |
| 1.1 Problem Description . . . . .                       | 1    |
| 1.2 Purpose and Goals . . . . .                         | 2    |
| 1.3 Summary of Contributions and Organization . . . . . | 3    |
| 2 Background . . . . .                                  | 5    |
| 2.1 SCADA . . . . .                                     | 5    |
| 2.1.1 Monolithic Architecture . . . . .                 | 6    |
| 2.1.2 Distributed Architecture . . . . .                | 6    |
| 2.1.3 Networked Architecture . . . . .                  | 7    |
| 2.1.4 Network Composition . . . . .                     | 8    |
| 2.1.5 PLC Composition . . . . .                         | 8    |
| 2.1.6 Threats . . . . .                                 | 10   |
| 2.1.7 Attacks . . . . .                                 | 12   |
| 2.2 Firmware . . . . .                                  | 14   |
| 2.3 Related Research . . . . .                          | 16   |
| 2.3.1 File Carving . . . . .                            | 17   |
| 2.3.2 Code Classification . . . . .                     | 25   |
| 2.4 Statistical Measures . . . . .                      | 26   |
| 3 Methodology . . . . .                                 | 29   |
| 3.1 Problem Definition . . . . .                        | 29   |
| 3.2 Approach . . . . .                                  | 29   |
| 3.3 System Boundaries . . . . .                         | 32   |
| 3.4 Workload . . . . .                                  | 33   |
| 3.5 Performance Metrics . . . . .                       | 35   |
| 3.6 Experimental Design . . . . .                       | 36   |

|   | Page |
|---|------|
| 3.7 System Implementation . . . . .                           | 37   |
| 3.8 Methodology Summary . . . . .                             | 38   |
| 4 Results and Analysis . . . . .                              | 39   |
| 4.1 File Segmenting Algorithms . . . . .                      | 39   |
| 4.2 Classifier Analysis . . . . .                             | 44   |
| 4.2.1 Fileprints . . . . .                                    | 44   |
| 4.2.2 Statistical . . . . .                                   | 50   |
| 4.2.3 Normalized Compression Distance . . . . .               | 51   |
| 4.2.4 Decision Tree . . . . .                                 | 53   |
| 4.3 Classifier Accuracies . . . . .                           | 56   |
| 4.3.1 Fileprints . . . . .                                    | 56   |
| 4.3.2 File Statistics . . . . .                               | 60   |
| 4.3.3 Normalized Compression Distance . . . . .               | 62   |
| 4.3.4 Code Classifiers . . . . .                              | 66   |
| 4.4 Whole Pipeline . . . . .                                  | 67   |
| 4.5 Opcode Analysis . . . . .                                 | 70   |
| 4.6 Firmware Disassembly . . . . .                            | 74   |
| 4.6.1 <i>PPC &amp; ZLib</i> - Firmware 99449204.bin . . . . . | 75   |
| 4.6.2 <i>ARM &amp; ZLib</i> - Firmware PN-20028.bin . . . . . | 80   |
| 4.6.3 <i>ARM Only</i> . . . . .                               | 83   |
| 4.6.4 Strengths and Weaknesses . . . . .                      | 83   |
| 5 Conclusions . . . . .                                       | 85   |
| 5.1 Limitations . . . . .                                     | 86   |
| 5.2 Future Work . . . . .                                     | 87   |
| Appendix A: Disassembly at Four Offsets . . . . .             | 90   |
| Appendix B: Opcode Frequency Analysis . . . . .               | 99   |
| Bibliography . . . . .  | 117  |



## List of Figures

| Figure   | Page |
|--|------|
| 2.1 Example SCADA network diagram . . . . .  | 9    |
| 3.1 Block diagram of the Firmware Disassembly System . . . . .                     | 30   |
| 3.2 Firmware Disassembly System boundaries, inputs, and outputs . . . . .          | 32   |
| 4.1 File segmenter performance . . . . .   | 40   |
| 4.2 Fileprint of random files . . . . .  | 46   |
| 4.3 Fileprint of GZip training files . . . . .                                     | 47   |
| 4.4 Fileprint of JPEG training files . . . . .                                     | 47   |
| 4.5 Fileprint of Text training files . . . . .                                     | 48   |
| 4.6 Fileprint of PostScript training files . . . . .                               | 48   |
| 4.7 Fileprint of GIF training files . . . . .                                      | 49   |
| 4.8 Fileprint of code training files . . . . .                                     | 49   |
| 4.9 Statistical classifier model . . . . .   | 50   |
| 4.10 Decision tree classifier model . . . . .                                      | 54   |
| 4.11 Decision tree leaf use on the training set . . . . .                          | 55   |
| 4.12 Decision tree leaf use on the test set . . . . .                              | 55   |
| 4.13 Proportions of opcode type . . . . .  | 74   |
| 4.14 Symbol table contained in firmware 99449204.bin . . . . .                     | 79   |
| 4.15 Code from the function <code>UsrInit</code> . . . . .                         | 80   |
| 4.16 A portion of the IDA Pro code diagram for <code>PN-20028.bin</code> . . . . . | 82   |
| 4.17 Summary of system performance on firmware 99449204.bin . . . . .              | 84   |
| 4.18 Summary of system performance on firmware <code>PN-20028.bin</code> . . . . . | 84   |

## List of Tables

| Table  | Page |
|--|------|
| 1.1 Summary of contributions . . . . .   | 4    |
| 2.1 Confusion matrix for a two-way classifier . . . . .                              | 26   |
| 2.2 Confusion matrix for an $n$ -way classifier . . . . .                            | 27   |
| 3.1 Characteristics of the test and training set file corpus . . . . .               | 34   |
| 4.1 Performance vs. parameter value for the sliding window algorithms . . . . .      | 42   |
| 4.2 Performance vs. parameter value for the entropy algorithms . . . . .             | 43   |
| 4.3 Training set characteristics . . . . .   | 45   |
| 4.4 NCD classifier training corpus model statistics . . . . .                        | 52   |
| 4.5 Decision tree leaf use on the test and training set . . . . .                    | 56   |
| 4.6 Test set characteristics . . . . .   | 57   |
| 4.7 Producer accuracy confusion matrix for the Fileprints classifier . . . . .       | 58   |
| 4.8 Consumer accuracy confusion matrix for the Fileprints classifier . . . . .       | 59   |
| 4.9 Fileprints classifier error summary . . . . .                                    | 60   |
| 4.10 Producer accuracy confusion matrix for the file statistics classifier . . . . . | 61   |
| 4.11 Consumer accuracy confusion matrix for the file statistics classifier . . . . . | 62   |
| 4.12 File statistics classifier error summary . . . . .                              | 63   |
| 4.13 Producer accuracy confusion matrix for the NCD classifier . . . . .             | 64   |
| 4.14 Consumer accuracy confusion matrix for the NCD classifier . . . . .             | 65   |
| 4.15 NCD classifier error summary . . . . .  | 66   |
| 4.16 Code classifier omission and commission errors . . . . .                        | 67   |
| 4.17 Overall accuracy summary, and 95% confidence interval . . . . .                 | 68   |
| 4.18 Producer accuracy summary by file type, and 95% confidence interval . . . . .   | 69   |
| 4.19 Most frequent opcodes from four architectures . . . . .                         | 71   |

| Table  | Page |
|--|------|
| 4.20 Categorization of firmware contents . . . . .         | 75   |
| 4.21 Summary of Foremost output for the firmware . . . . . | 76   |
| 4.22 Contents of firmware 99449204.bin . . . . .           | 78   |
| 4.23 Contents of firmware PN-20028.bin . . . . .           | 81   |
| A.1 Offset zero disassembly . . . . .                      | 91   |
| A.2 Offset one disassembly . . . . .                       | 92   |
| A.3 Offset two disassembly . . . . .                       | 93   |
| A.4 Offset three disassembly . . . . .                     | 94   |
| A.5 Offset zero opcode analysis . . . . .                  | 95   |
| A.6 Offset one opcode analysis . . . . .                   | 96   |
| A.7 Offset two opcode analysis . . . . .                   | 97   |
| A.8 Offset three opcode analysis . . . . .                 | 98   |
| B.1 Top 100 opcodes for ARM . . . . .                      | 99   |
| B.2 Top 100 opcodes for Motorola 68000 . . . . .           | 103  |
| B.3 Top 100 opcodes for PowerPC . . . . .                  | 107  |
| B.4 Top 100 opcodes for AVR . . . . .                      | 112  |

## List of Acronyms

| Acronym | Definition  |
|---------|---|
| APT     | advanced persistent threat                          |
| ASCII   | American Standard Code for Information Interchange  |
| BMP     | bitmap  |
| CE      | Compact Edition                                     |
| CERT    | computer emergency response team                    |
| CI      | critical infrastructure                             |
| COTS    | commercial off-the-shelf                            |
| CPU     | central processing unit                             |
| DHS     | Department of Homeland Security                     |
| DNS     | Domain Name System                                  |
| EDS     | electronic data sheet                               |
| EEPROM  | electrically erasable programmable read-only memory |
| ELF     | Executable and Linkable Format                      |
| EPROM   | erasable programmable read-only memory              |
| FAT     | File Allocation Table                               |
| FTP     | File Transfer Protocol                              |
| GIF     | Graphics Interchange Format                         |
| GUI     | graphical user interface                            |
| HMI     | human-machine interface                             |
| HTML    | HyperText Markup Language                           |
| I/O     | input/output  |
| ICMP    | Internet Control Message Protocol                   |
| ICS     | Industrial Control System                           |

| Acronym | Definition                                |
|---------|---|
| IEC     | International Electrotechnical Commission |
| IG      | information gain                          |
| IP      | Internet Protocol                         |
| JPEG    | Joint Photographic Experts Group          |
| $k$ -NN | $k$ -Nearest Neighbor                     |
| LAN     | local area network                        |
| LZMA    | Lempel-Ziv-Markov chain algorithm         |
| LZW     | Lempel-Ziv-Welch                          |
| NCD     | normalized compression distance           |
| NIC     | network interface card                    |
| NTSB    | National Transportation Safety Board      |
| OS      | operating system                          |
| PC      | personal computer                         |
| PCA     | principal component analysis              |
| PDD     | Presidential Decision Directive           |
| PDF     | Portable Document Format                  |
| PLC     | Programmable Logic Controller             |
| RAM     | random-access memory                      |
| RMSE    | root mean square error                    |
| RPC     | remote procedure call                     |
| RTU     | Remote Terminal Unit                      |
| SCADA   | Supervisory Control And Data Acquisition  |
| SMTP    | Simple Mail Transfer Protocol             |
| SNMP    | Simple Network Management Protocol        |
| SVM     | support vector machine                    |

| Acronym | Definition                 |
|---------|----------------------------|
| TI      | Texas Instruments          |
| US      | United States              |
| WAN     | wide area network          |
| XML     | Extensible Markup Language |

# FILE CARVING AND MALWARE IDENTIFICATION ALGORITHMS APPLIED TO FIRMWARE REVERSE ENGINEERING

## 1 Introduction

### 1.1 Problem Description

Programmable Logic Controllers (PLCs) quietly manage dozens of systems that modern society depends on every day. PLCs, in turn, depend on firmware. Firmware is a black box to control system operators, as they have no control or knowledge of its contents. Though largely ignored in the past, recent security research focuses on firmware [69–73]. Researchers now routinely find remotely-exploitable PLC firmware bugs.

Few published efforts reveal PLC internals. Schwartz et al. focus on the hardware internals [58], Peck and Peterson manually reverse engineer two firmwares but their discussion does not focus on firmware contents [48], and McMinn considers the communications protocols PLCs use to update firmware [41]. Manufacturers consider many specifications proprietary, including processor architecture, and in most cases devices are too expensive or mission critical to disassemble.

The networked generation of Industrial Control System (ICS) hardware enables operators to make economic decisions which compromise system security. Operators connect their critical infrastructure (CI) systems to their business networks to enable improved customer service or less expensive long distance control. Attacking ICSs once required a sophisticated, well-financed attacker. Recent high-profile incidents, like that which *prof\_srs* claimed in 2011, show that ICS attacks no longer require many resources [53]. More sophisticated attacks like Stuxnet now target PLCs specifically, but have not yet attacked or modified PLC firmware [11]. History shows that these attacks are

likely coming. Open-source firmware projects for wireless routers [45, 63] and music players [64], and published modifications of other firmware [19, 43], indicate that even unsophisticated attackers will perpetrate PLC firmware attacks.

Once a system operator discovers that an attacker compromised their device, they must determine the extent and effect of that compromise. Analysis requires a measure of firmware reverse engineering. Unfortunately firmware is a black box to the user and a proprietary, undocumented, binary blob to the researcher. Header format is arbitrary, and varies between manufacturer and even model. Devices may reorder or uncompress sections at several times, and may load code segments with arbitrary offsets. Devices may skip installing firmware sections based upon hardware configuration. These device activities complicate analysis, because firmware images retrieved with chip debugging tools differ from pristine firmware images. Fortunately, manufacturers do not seem to purposely obfuscate firmwares.

## 1.2 Purpose and Goals

The reverse engineering process is tedious [3]. It requires detailed analysis even before disassembling code segments. Consequently, few analyses of PLC firmwares exist, academic or otherwise. This research effort's goal is to automate firmware reverse engineering. Specifically, this research automates the steps of reverse engineering prior to code analysis. It characterizes the performance of file carving and malware identification algorithms when applied to firmware reverse engineering. This paper describes the steps of firmware reversing, describes an implementation of those steps in the *Firmware Disassembly System*, characterizes the system's performance, and presents some PLC firmware disassembly results.

Until recently, little need existed for efficient PLC firmware reverse engineering. Forensics teams did not require the capability, and researchers had luck discovering security vulnerabilities with externally-applied techniques like fuzzing [16]. Slow reverse



engineering methods sufficed for the patient researcher. This requirement changed with the proliferation of Internet connectivity for attackers and CI alike.

The *Firmware Disassembly System* simplifies firmware reverse engineering. Firmwares often include compressed segments [48], and the system finds and uncompresses those. Complex firmwares often include web-server functionality including documentation or status outputs, so the system identifies likely data segments containing common file types. The *Firmware Disassembly System* finds segments containing executable code, identifies the target architecture and disassembles that code, then performs rudimentary analysis on the result.

This research hypothesizes that of the three file type identification algorithms it considers, Axelsson's normalized compression distance (NCD) algorithm provides the most accurate type identification [7]. Axelsson's experimental configuration involves more file types than the other researchers', and his  $n$ -valued classification results showed greater accuracy, for several file types, than the other algorithms.

Of the two code segment architecture classification algorithms this research considers, it hypothesizes that Kolter and Maloof's boosted decision tree algorithm provides the most accurate architecture and endianness detection [35]. In three out of four experimental configurations, boosted decision trees provide the most accurate malware classification. In the fourth configuration boosted decision trees provide the second most accurate classification. support vector machines (SVMs) produce the second most accurate classification when averaged over the four configurations.

### 1.3 Summary of Contributions and Organization

Table 1.1 summarizes this research's contributions. Chapter 2 discusses the security problems that motivate this research, and related work. Next, Chapter 3 concerns testing methodology and system implementation. Chapter 4 discusses test results, and investigates the reason for those results. Finally, Chapter 5 provides closing discussion.

Table 1.1: Summary of contributions

| <b>Contribution</b>   | <b>Relevant Section</b> | <b>Related Work</b>  |
|---|-------------------------|--|
| Survey of related work  | Chapter 2               | Academic: [9, 46]  |
| Pseudo-firmware construction method   | Section 3.4             |  |
| Firmware disassembly toolkit<br>construction  | Section 3.7             |  |
| Evaluation of file segmenting algorithms  | Section 4.1             | Academic: [15, 33, 44]   |
| File carving algorithm application to<br>firmware, and evaluation                                   | Section 4.3             | Academic: [5, 7, 12, 15, 23, 32, 33, 36, 38, 40, 44, 52, 60, 67, 74, 80]<br>Non-academic: [81] |
| Evaluation of malware classification<br>algorithm applied to<br>architecture-classification problem | Section 4.3             | Academic: [35]   |
| Opcode frequency analysis   | Section 4.5             |  |
| PLC firmware content analysis   | Section 4.6             | Academic: [18, 25, 79]<br>Non-academic: [19, 28, 29, 43]                                       |

## 2 Background

This chapter provides an overview of Supervisory Control And Data Acquisition (SCADA) technology and its components. It discusses existing threats to SCADA infrastructure, then discusses known and theoretical attacks against SCADA. The chapter then provides a basic overview of device firmware. It considers firmware's function and complexity, then discusses firmware attacks. Finally, this chapter provides an overview of related research including firmware analysis in other fields, research into file carving, and compiled code architecture classification efforts.

### 2.1 SCADA

SCADA systems, and more generally ICS networks, control and monitor a diverse set of modern industrial processes. Services including gas and electricity distribution, water and wastewater control, telecommunications, and food processing rely on these systems to provide a modern level of performance [8]. These processes are too complex to monitor and control economically without automation techniques. SCADA and ICS systems make these processes feasible by gathering data from remote sites, then correlating and displaying it at an operator terminal. SCADA systems first came into prominence in the 1960's and have since evolved, along with computing itself [39].

SCADA systems are a part of the United States CI as Presidential Decision Directive (PDD)-63 defined in 1998 [13]. CI includes public and private "physical and cyber-based systems essential to the minimum operations of the economy and government". The directive acknowledges that in the past these systems were separate and independent, but recent automation and interconnection introduced vulnerabilities. PDD-63, and the Homeland Security Presidential Directive-7 in 2003 [10], establish United States (US)

policy regarding CI security. This section describes changes in SCADA infrastructure over the years, and their motivation.

### **2.1.1 Monolithic Architecture**

Initially, SCADA systems worked independently and in isolation, in a configuration similar to server mainframes. These characteristics defined the *monolithic* phase of SCADA architecture because one central unit, the *SCADA Master*, provided all computing and monitoring functionality [39].

The lack of widespread networks and networking standards required every manufacturer to develop a proprietary system. Generally, the protocols did not tolerate other network traffic and were not easily extensible. Manufacturers designed and installed each SCADA system uniquely. The proprietary nature of the system software, networking, and even the connectors, required the manufacturer to perform most system modifications.

Monolithic systems provided fault tolerance through *SCADA Master* redundancy. A secondary system duplicated all functions of the primary, and monitored the primary's operation. When the secondary detected a fault it took over all operations. In general, the secondary greatly increased system cost but performed little work.

### **2.1.2 Distributed Architecture**

In the late 1980's personal computers became more affordable, and local area network (LAN) protocols became more standardized. These changes enabled SCADA architectures that distributed operator functionality and processing across multiple systems. Individual computers acted as human-machine interface (HMI) stations, as historian computers, and in many other roles [39].

While manufacturers used standard LAN technologies to connect operator stations, these networks had limited range. Many industrial processes still required communications between geographically scattered equipment. Manufacturers continued to use proprietary

protocols developed during the monolithic architecture phase, and their makeshift wide area networks (WANs) were effectively single-use.

Distributed architecture SCADA systems only contained vendor-provided equipment. Often, only the vendor could perform system maintenance and upgrades. The distributed architecture enabled more flexible and economical fault tolerance, however. Often, other system components could handle the operations of failed system components in addition to their own tasks. Thus, distributed architecture systems did not require full-time standby systems.

### ***2.1.3 Networked Architecture***

Finally, in the mid 1990's manufacturers began to use largely commercial off-the-shelf (COTS) networking hardware and computer systems. They began to standardize protocols for end-devices like PLCs and Remote Terminal Units (RTUs), which enabled protocol transport over standard WAN networks. Standard protocols enabled companies to make in-house modifications to their SCADA networks, and to lower costs by leveraging their existing network infrastructure [39].

The networked SCADA architecture gave organizations greater flexibility in their operations. Connection with the business network for performance tracking and billing purposes became simple [39]. Networked architectures also enabled off-site backup and fault-tolerance, enabling systems with the ability to survive disasters affecting entire geographical regions.

For all the benefits, the networked generation created new issues regarding system security and reliability. Unexpected interaction between SCADA and business systems caused reliability issues. Manufacturers' use of standard network protocols lowered the bar to system exploitation, and integrating CI and business network infrastructure expanded the potential attack surface-area [39].

#### ***2.1.4 Network Composition***

SCADA networks have a hierarchical structure, as Figure 2.1 shows. Sensors and actuators comprise the lowest level, and the sensor network connects them to PLCs and RTUs. Sensor network connections are generally short, and analog. PLCs and RTUs consolidate control over the sensors and actuators, then SCADA master units control the PLCs and RTUs via the field network. Field networks consist of longer-distance links than the sensor network. Modern field networks consist of Ethernet, serial cable, microwave radio, telephone, and many other connections [8].

The control centers provide centralized operator control over the system, and include terminals such as HMIs and data historians. Respectively, these enable operator control over a physical process, and long term system state storage. Modern control centers consist of COTS computer and networking hardware, running COTS operating systems and custom control software. For example, Siemens' SIMATIC WinCC product supports several operating systems, from Microsoft Windows XP through Windows 7 [59]. SIMATIC WinCC is Siemens' primary control system software product, and Siemens is one of the largest ICS manufacturers [58].

Increasingly, companies connect control centers to their business networks. Generally they make this connection through a COTS firewall. Business network connections enable companies to manage expenses and billing in real time, and to save costs by leveraging existing long-distance network connections. These connections also introduce vulnerabilities into the control system because many business networks have connections to external networks like the Internet.

#### ***2.1.5 PLC Composition***

The general PLC hardware architecture is modular, with some PLCs permitting end-user module configuration, and others permitting only manufacturer configuration [58]. Modules communicate via the backplane and include processor, communications, and

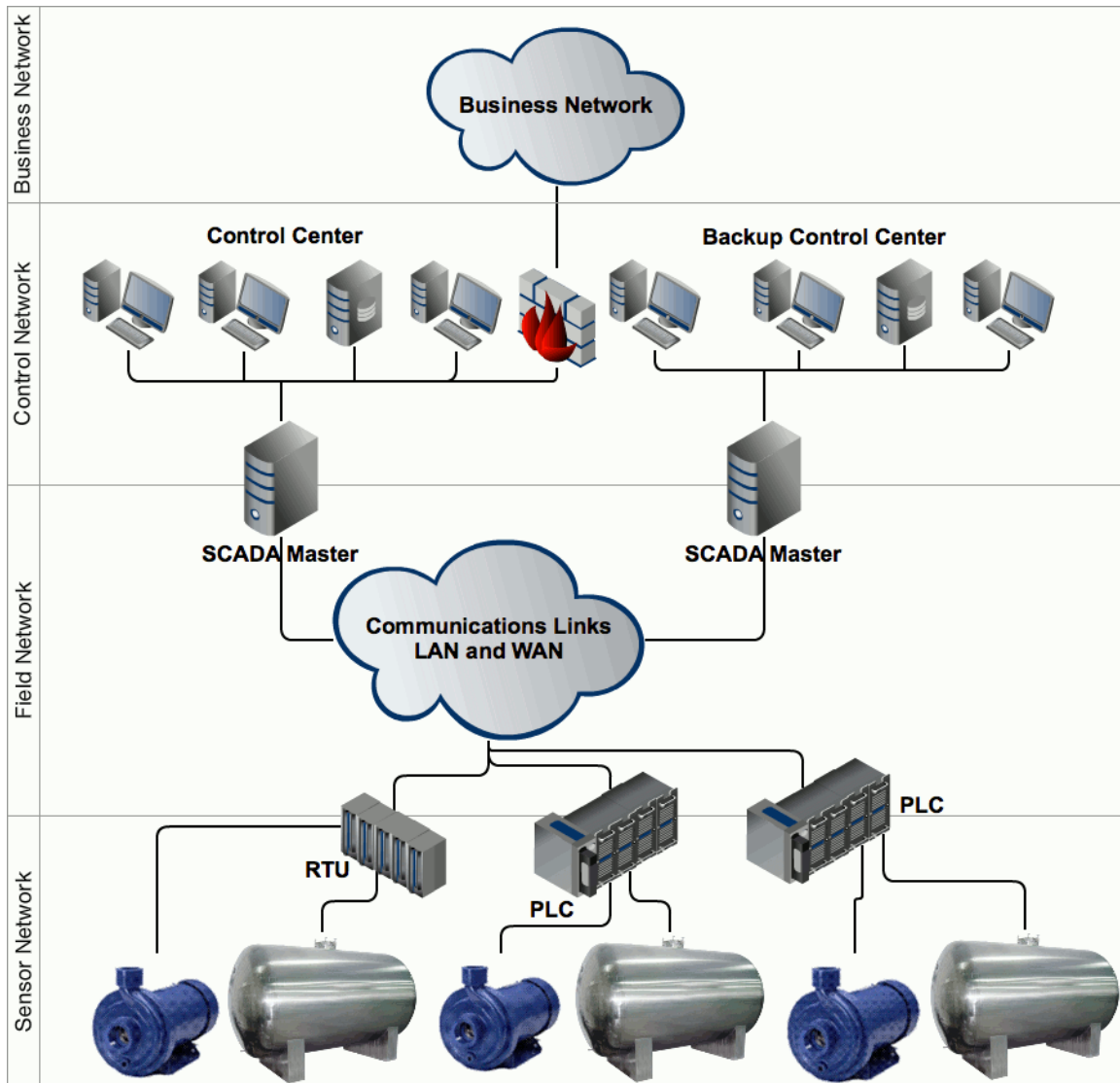

Figure 2.1: Example SCADA network diagram

input/output (I/O) modules. The processor module executes ladder-logic code to manage physical processes, coordinates between the other modules, and even handles simple field network communications if the PLC does not include a communications module. As such, the processor module is generally the most complex.

The communications module is of similar complexity to the processor. The module handles time-sensitive network communications, and frees the processor module to manage

time-sensitive physical processes [58]. Communications modules handle multiple types of network communications, including Internet Protocol (IP) over Ethernet and RS-422.

I/O modules output and input analog signals based upon commands from the processor module [58]. These modules read gauges and switch positions, and control motors and solenoids. I/O modules require the least intelligence, as their function is to process simple backplane commands and manage digital/analog conversion hardware.

All three PLC modules contain microprocessors, and the most common processor architectures are ARM, Motorola 68000 and PowerPC [58]. The processors execute code contained in PLC firmware, and generally stored in nonvolatile flash memory. Additionally, the processors interpret operator instructions regarding physical processes. Proprietary software derives the instructions from one of the simple programming languages defined in International Electrotechnical Commission (IEC) 61131-3 [31]. The specification defines the Ladder Diagram, Function Block Diagram, Structured Text, and Instruction List languages. Operators commonly call instructions in these languages *ladder-logic*.

#### **2.1.6 Threats**

The Department of Homeland Security (DHS) defines five groups of cyber threats, depicted below in order of increasing consequence and decreasing threat frequency [17]. Nuisance hackers comprise the overwhelming majority of cyber attacks and include groups such as *hacktivists*, individuals that use cyber action as a form of protest or to achieve political ends [56]. Despite the group's lack of resources and the general low complexity of their attacks, nuisance hacker attacks occasionally cause significant economic consequence [42]. Notoriety, mischief, or publicity for a cause frequently motivate nuisance hackers. Money motivates criminals and gangs, who have resources which enable attacks of greater complexity than nuisance hackers. The DHS list of cyber threats is:

1. Nuisance Hackers
2. Criminals and Gangs



3. Nation-States Motivated by Theft
4. Limited Resource Nation-States and Terrorists
5. Unlimited Resource Nation-States

Threat groups three through five possess significantly more resources [17]. Each has the ability to seize control, through force, of corporations which produce cyber technology. Military concerns motivate each, and economic and diplomatic concerns motivate all but terrorists. Group three includes nation-states that steal private intellectual property and national secrets. This threat group's actors are unwilling to cause physical damage with their actions, though they possess that capability. The limited and unlimited resource groups are willing to cause physical damage. Money, time, or technical access may limit the limited resource actors. Unlimited resource actors attack with monetary resources, technical access, and speed, that overwhelm any adversary.

Attacks on the older, distributed architecture, SCADA systems, require physical access and special network equipment. These requirements demand a moderate amount of attacker resources. Attacks demand long-term planning, and that reduces attack payoff.

Modern networked SCADA systems lower the bar to attacker entry. Their connections to the Internet, and use of common network protocols, enable nuisance hacker attacks. Search engines like *SHODAN* make searching for Internet-facing SCADA networks simple [68]. *SHODAN* and tools like *Metasploit* and *THC-Hydra* enable nuisance hacker SCADA HMI attacks.

System operators can recognize many simple cyber attacks by their immediate system effects, but the term advanced persistent threat (APT) describes a more insidious attacker [66]. Long term reconnaissance and data exfiltration characterize the APT. These actions require more resources than nuisance hackers possess, and until recently required

more resources than criminals possessed. The proliferation of network attack tools and knowledge enables organized criminals to act as APTs.

The *insider* threat and self-inflicted malfunction form a sixth threat category [62]. Insiders are employees and business associates that intentionally cause damage to an organization. They work with an external actor, or alone, to sabotage the organization. Insiders do not require many resources because their position grants them access to critical systems. Separately, self-inflicted malfunction causes unintentional damage to an organization, and occurs due to operator error or equipment failure.

Emergency responders found self-inflicted malfunction as the cause of several SCADA emergencies, although attribution is notoriously difficult when an incident includes cyber assets. The National Transportation Safety Board (NTSB) attributed a gasoline pipeline leak in Bellingham, Washington, to pipeline damage and degraded SCADA software performance [1]. The leak and a subsequent explosion resulted in three deaths. Investigators were unable to determine the cause of the software performance degradation, but determined that it was likely due to an administrator's configuration update on the live system. The investigators also found several network security issues that could have led to the pipeline leak, leaving open the possibility of an intentional attack.

### **2.1.7 Attacks**

Vitek Boden attacked the Maroochy Shire Council sewage system in 2000 in the first well-known ICS attack [2]. He stole equipment from Hunter Watertech, his former employer and the company which installed the SCADA system, then used the equipment to sabotage the system's operation. The system lacked cyber defenses, and its security relied on the obscurity of the system's radio communication frequencies and protocols.

Vitek disabled sewage pumps and sensor alarms, and disrupted remote station communications at several locations over a period of three months [2]. Initially, operators attributed malfunction to installation error. A lack of cyber defense logs and tools, and

Vitek's actions to hide his attacks, led system operators to that incorrect conclusion. Vitek's success was due to his theft of equipment and a lack of cyber defense, and as such his attack was of low complexity.

Attacker *prof.srs* broke into the water infrastructure for South Houston, Texas, in 2011 [53]. He claimed that the SCADA system used a three letter password, and that knowledge of the system's software, and guessing the password, allowed him control over the system. The attacker posted screenshots of the control system to Twitter and claimed that the attack was partly in response to public DHS statements [65]. This attack was of low complexity, and the attacker acted as a hacktivist in this instance.

Stuxnet is a computer worm that targets particular ICS hardware configurations and sabotages their operation [11]. Specifically, Stuxnet targets Siemens' SIMATIC PCS 7, an industrial automation system in which the operator terminals execute Microsoft Windows. It uses four exploits to propagate: a Windows shortcut vulnerability, shared network folders, a Windows remote procedure call (RPC) vulnerability, and a Windows printer sharing vulnerability [37]. Stuxnet uses several other Windows vulnerabilities to increase its privileges.

Stuxnet modifies code on PLCs to vary the speed of motors [24]. The modified motor speed sabotages the industrial process controlled by the motor. Some researchers count Stuxnet among the most complex threats they have analyzed. It exploits at least four previously-undisclosed bugs, and analysis shows that an organized team with delineated responsibilities likely built its components [37]. Analysts believe that constructing the Stuxnet worm required resources beyond the capabilities of all but a few attackers [24]. The complexity and consequences of Stuxnet suggest that the attacker belonged to threat groups four or five: limited resource nation-states and terrorists, or unlimited resource nation-states.

## 2.2 Firmware

Firmware exists on the boundary of hardware and software. Firmware controls the start-up sequence of modern personal computers (PCs), enabling low-level user configuration and transfer to larger, more complex operating systems (OSs). Firmware eases startup by permitting modern OSs access to a standard interface, abstracting out many differences in PC hardware. Modern PCs store firmware in electrically erasable programmable read-only memory (EEPROM) chips, and store the main OS on storage external to the system motherboard.

In contrast, firmware often provides all system software functionality for embedded devices. Due to space and durability requirements embedded devices often do not contain storage external to the motherboard, and can therefore only execute an OS stored in EEPROM or flash memory. Little reason exists, then, for firmware to transfer control to any other entity, and manufacturers incorporate a full OS and all software in the firmware.

Generally, PC OSs and software provide simple update techniques, enabling users to patch insecure software quickly once manufacturers release updates. Updates to firmware require more user effort. Many systems require that the user reboot into maintenance mode or manipulate hardware switches. Performance or safety-critical devices may require disconnection from the rest of the system. Firmware's critical function also makes testing procedures more vital than for conventional software. These complications make firmware security vulnerabilities more valuable to attackers.

Dacosta et al. reverse engineer the firmware of a Cisco 7960G IP phone [18]. They first disassemble the binary firmware image, retrieving the assembly code for the phone's ARM processor. Then they manually perform control and data flow analysis to look for potential software vulnerabilities. Firmware image disassembly requires several steps. First, the researchers note that the firmware image consists of a compressed ZIP archive

containing five named files. They deduce the contents of the files, then character strings within the files identify the phone processor's architecture.

Once they determine the code's target architecture, the researchers possess much of the information they require for code disassembly. Dacosta et al. manually analyze and determine the contents of the file headers. They disassemble the appropriate code sections and analyze addresses in switch statement jump tables to determine the code's memory mapping. The researchers identify C library functions that commonly lead to security vulnerabilities, including `strcpy`, `malloc`, and `sprintf`, then begin manual code analysis from those points.

Critically, Dacosta et al. note that they are not aware of tools that automate analysis of ARM binaries. They use IDA Pro to perform the majority of their analysis. They use their intuition to perform the initial analysis of the binary firmware image. They have success relying on standard compression tools to unpack most of the image, and relying on character strings to reveal the target architecture.

Delugré analyzes and modifies the firmware for a Broadcom Ethernet network interface card (NIC) [19]. The Linux kernel contains the binary firmware image in an undocumented format. Delugré determines that the firmware targets a MIPS processor by locating the central processing unit (CPU) model on the physical device. He uses a modified Linux kernel driver to retrieve the firmware from the NIC while in operation. The process reveals the relevant memory addresses for code analysis and disassembly. After retrieving the NIC firmware code, Delugré discusses how to compile and install firmware with covert communications capabilities.

Miller disassembles the firmware of an Apple MacBook smart battery [43]. He destructively disassembles the hardware to determine its components. The researcher removes the Texas Instruments (TI) chips containing the firmware and uses TI software to retrieve the firmware image. Miller manually analyzes the firmware contents and,

although TI holds the firmware's target architecture as proprietary information, the researcher determines the target architecture from the format of several instructions. Miller successfully modifies the battery firmware to report incorrect values for battery capacity and charge.

Yasinsac et al. analyze the security of voting machine firmware [79]. They use static code analysis and manual code review to find vulnerabilities in Florida voting machines. The machines contain external storage (Compact Flash and a proprietary voting ballot device) and on-board flash memory. An erasable programmable read-only memory (EPROM) chip contains the voting machine firmware, but the manufacturer provides the researchers with the firmware source code. The firmware contains all application code, and was written entirely by the vendor, with the exception of the Compact Flash driver and C standard library. Yasinsac's review finds several buffer overflow vulnerabilities, and the researchers theorize about potential problems with the general voting security process.

Fogie applies firmware reverse engineering techniques to Windows Compact Edition (CE) embedded systems [25]. He discusses the basics of the ARM architecture, and applies several common reverse engineering tools to real firmware. Hurman goes into similar detail about Windows CE, but focuses on exploiting bugs and crafting shellcode [29]. His analysis discusses embedded system software analysis using reverse engineering techniques. Grand discusses general security concerns regarding firmware code, and suggests that manufacturers incorporate code signing and encryption [28]. He notes that they can immediately increase security by removing firmware images from public websites. Grand also points out that manufacturers can use obfuscation to discourage the majority of attackers.

### **2.3 Related Research**

This research effort develops techniques to automate the firmware analysis process. No known research considers firmware analysis as a rigorous process, but some research

analyzes embedded system firmware, and the individual activities required for firmware disassembly are active areas of research.

Peck and Peterson perform some related work in [48], where they disassemble the firmwares for two PLC Ethernet modules. The authors separate program code from the Rockwell 1756 ENBT and Koyo H4-ECOM100 Ethernet module firmwares, then demonstrate a proof-of-concept modification of the Rockwell firmware. They place their firmware modification within the firmware's File Transfer Protocol (FTP) server code, and program it to send an Internet Control Message Protocol (ICMP) ping to a remote host periodically. The authors update a target PLC over an Ethernet network, and find that the PLC performs no authentication of the firmware code or of the personnel performing the firmware update. Both devices update firmware over custom protocols, and current COTS firewalls do not understand those protocols. In addition to the firmware modification, the authors demonstrate cross-site scripting attacks on both Ethernet modules' web servers. The Rockwell device also provides FTP and Simple Network Management Protocol (SNMP) servers, and both servers have authentication vulnerabilities.

With their paper, Peck and Peterson demonstrate that malicious firmware modification and installation, while not simple, is within the realm of the determined hacker. They outline several situations where this form of attack benefits the attacker. The authors conclude that system operators must be vigilant with PLC network security. Ultimately, the proprietary nature of PLC firmware requires that vendors take action to improve security. SCADA asset owners must hold vendors accountable by taking security into account when purchasing equipment.

### **2.3.1 File Carving**

Firmware images contain many component segments, including code and data segments. Separating data from code is an initial step in firmware disassembly. File carving is an active area of research in the digital forensics field that involves identifying

and recovering files from hard disks, including partially destroyed disks. File carving techniques are applicable to firmware image disassembly, and this section describes several file carving research efforts.

Traditional file carvers search for file *magic numbers*, sequences of bytes that identify the headers or footers of particular file types. The UNIX `file` command has existed since at least 1973, and is the most well-known example of anything like a traditional file carver [81]. The `file` command has a flexible configuration file which specifies magic numbers for hundreds of file types. In general, it does not search for multiple sections and file types within a file.

`Foremost` searches for magic numbers in both headers and footers, and carves the appropriate section [46]. The United States Air Force Office of Special Investigations developed the tool, and it is now an open-source project. Its configuration file allows users to specify new file types by adding the header and footer magic numbers. `Scalpel` is a traditional file carver Richard et al. designed for high performance [52]. Richard outlines requirements for a high performance file carver, and implements those requirements by improving `Foremost`.

Sites et al. describe a system for binary code translation between two architectures [60]. The system locates the code within an executable, then translates it for a second architecture. An executable's header and symbol table describe the entry points for much of the code, but can skip some. Sites' system attempts to find other code by scanning through sections skipped by the header and symbol table, including groups of valid instructions which end in an unconditional branch or jump.

Underwood extends context-free grammars to describe the format of binary files, and validates a binary file's format via a context-free grammar parser [67]. The technique can detect file format more accurately than simple magic number detection, but requires much



more metadata describing each format. The technique is most useful for finding well-formed files, or detecting which file parts are not well-formed.

McDaniel and Heydari first describe *fingerprinting* file types with byte frequency analysis [40]. For each training file, their system generates an array of normalized frequencies for each byte value. The system averages all files of a particular type, then calculates a *correlation strength* similar to variance, to generate a fingerprint for that type. The researchers create an algorithm to compute a test file's similarity to each fingerprint, then classify the test file's type as that of the most similar fingerprint. Their test set contains 30 file types, and the classifier performs 30-class classification. When relying on file headers and footers, their algorithm achieves a 96% accuracy. Otherwise, it achieves only a 46% accuracy.

Erbacher and Mulholland distinguish file and data type to facilitate the identification of compound file contents [23]. Compound files, like Microsoft Word Documents or firmware images, can contain other files in addition to their own data and metadata. Thus while a file's overall file type may be Word Document it also contains other data types, like images and spreadsheets, in their native file types. They apply 13 statistical file measures to a 7 file type test corpus, and find that the measures which best differentiate the test files by type are: average byte value, distribution of byte value averages, standard deviation, distribution of standard deviations, and kurtosis.

Moody and Erbacher describe a system, *SÁDI*, which applies 6 statistical techniques to data type identification [44]. Their techniques include distribution of byte values, and Erbacher and Mulholland's top five. They classify sections of test files using a sliding window which varies by file type, but is generally 256 bytes. This enables them to identify data types within a file. The system achieves 74% accuracy on 9-class classification.

In the Oscar file carver, Karresand and Shahmehri classify files with the normalized Euclidean distance to a file type centroid [33]. Their file type centroids consist of the byte

value frequency mean and standard deviation of a set of files belonging to that type. The researchers built Oscar to assist with hard disk analysis, so it classifies disk image sections with a disk-cluster sized sliding window of 4 kB, with a 4 kB step size. Karresand's test set concatenates 49 file types, and Oscar classifies each cluster as Joint Photographic Experts Group (JPEG) or not-JPEG. Oscar achieved a 98% true positive rate, 0.01% false positive rate, on the two-way classification problem.

Later, the researchers expand Oscar to consider a byte value rate-of-change frequency metric [32]. Their system calculates the absolute value of the distance between all consecutive bytes, then builds a histogram with those values. The rate-of-change values fall within the range 0 to 255. The system extends the original Oscar centroids with the rate-of-change means and standard deviations. Karresand and Shahmehri use the same distance metric for both byte value frequency and rate-of-change frequency centroids. With the extended system, the researchers boost classification accuracy on the JPEG two-way classification problem to a 99% true positive rate, 0% false positive rate.

Veenman uses a byte value histogram, entropy, and Kolmogorov complexity with a linear classifier to classify files [74]. His research considers both 2- and 11-class classification problems, over 11 file types. The use case in Veenman's research is digital forensics, thus his file corpus included common desktop file types. Veenman achieved the best accuracy, a 45% true positive rate, with 2-class classification.

Mayer applies long byte value  $n$ -grams, for  $2 \leq n \leq 20$ , to file type classification [38]. His research considers 25 file types common to office environments, and models file types with the long  $n$ -grams common to that type. To each test sample, the classifier assigns the file type that maximizes the number of common  $n$ -grams present. Mayer achieves a 48% accuracy on full files and a 22% accuracy on file segments. This large accuracy difference is due to his exclusion of file headers from the segments, but the inclusion of header  $n$ -grams in his file type models.

Amirani et al. apply principal component analysis (PCA) to extract classification features from the byte frequency distribution of test files [5]. They use the resulting features to train a neural network to classify files of 6 types. The neural network allows the researchers to achieve accurate classification, while PCA reduces the network size and training time. They classify Microsoft Word, Windows Executable, Portable Document Format (PDF), JPEG, HyperText Markup Language (HTML), and Graphics Interchange Format (GIF) files. The system achieves an overall accuracy of 98% when classifying file fragments that do not include headers or footers.

Calhoun and Coles perform 2-class file segment classification using Fisher's linear discriminant with 11 data statistics and 5 combinations of those statistics [12]. Their data statistics include: entropy, mean byte value, byte value standard deviation, correlation, longest common subsequence length, and byte value frequencies for bytes within a range. While their research only quantifies results of 2-class classification, they state that their technique applies to the more general  $n$ -value classification problem

Calhoun and Coles test their technique with two sets of GIF, JPEG and bitmap (BMP) files. The first set includes bytes 128 through 1024 of each file, and the second set includes bytes 512 through 1024. Including only part of each file enables them to test the accuracy of their technique when files do not include metadata, and when forensic investigators have only partially recovered a file. The statistic which performs best on the first test set is a combination of byte frequency over three ranges, entropy, byte frequency mode, and byte frequency standard deviation. This combination achieves 88.3% accuracy on the first set and 84.2% accuracy on the second. Longest common subsequence yields the best accuracy on the second set, at 86%, and 84.5% accuracy on the first set.

Axelsson uses NCD and  $k$ -Nearest Neighbor ( $k$ -NN) to perform  $n$ -value file segment classification [7]. NCD is an approximation of *normalized information distance*, which is a measure of data entropy. Axelsson defines NCD with Equation 2.1, where  $C(x)$  is

the compressed length of  $x$ , and  $C(x, y)$  the compressed length of  $x$  and  $y$  concatenated. He chooses `gzip` as the compression algorithm, and investigates settings of  $k$  from 1 to 10. The algorithm calculates NCD for 512 B test and training fragments, then assigns test segments the most common file type among the  $k$  lowest NCD values.

$$NCD(x, y) = \frac{C(x, y) - \min(C(x), C(y))}{\max(C(x), C(y))} \quad (2.1)$$

Axelsson's file corpus contains 17 file types including executable files, images, movies, and common document formats. He reports approximately 50% accuracy overall for the 17-value classification problem, but approximately 90% accuracy for several file types. Furthermore he finds that, among the tested values, no  $k$  value performed better than the others. Axelsson suggests that future work should consider classifying fragments into more generic file type classes.

Conti et al. classify 14,000 1 kB file fragments from 14 common file types using  $k$ -NN [15]. Their  $k$ -NN algorithm evaluates the distance between fragments with Euclidean and Manhattan distance over 4 file statistics: Shannon entropy using byte bigrams, byte value arithmetic mean, Chi Square Goodness of Fit of byte distribution to a random distribution, and Hamming weight. They define Hamming weight as the proportion of one bits in a segment. Equations 2.2 and 2.3 give the Shannon entropy and Chi Square equations, respectively. In Equation 2.2,  $p(X_i)$  represents the probability that byte value  $i$  occurs within a file fragment. In Equation 2.3,  $o_i$  represents the frequency of byte  $i$  within a file fragment, and  $e_i$  represents the expected frequency of byte  $i$  within a uniform random distribution. Conti et al. calculate Chi Square Goodness of Fit using the  $\chi^2$  value and a Chi Square distribution with 255 degrees of freedom. They determine that, for their test cases, Euclidean distance classifies file fragments more accurately than Manhattan distance.

$$H(x) = - \sum_{i=0}^{255} p(X_i) \log_2(p(X_i)) \quad (2.2)$$

$$\chi^2 = \sum_{i=0}^{255} (o_i - e_i)^2 / e_i \quad (2.3)$$

They extract file fragments from the approximate middle of sample files to avoid file headers and footers. Their 14 file types consist of compressed data in several formats, encrypted data, random data, base64 or uuencoded data, Linux ELF and Windows PE executable data, bitmap data, and mixed text data. During classification, Conti et al. test values of  $k$  from 1 to 25, and settle on  $k = 3$  because larger values provide no significant return. The classifier was unable to distinguish several file types during 14-value classification, so Conti et al. clustered each file type by *similarity*, making the problem 6-value classification. They clustered the random, encrypted and compressed data together, clustered the executable formats, and placed the other file types in individual clusters. Their classifier achieved 82.5% accuracy for bitmaps, and better than 96% accuracy for the 5 other clusters.

Li et al. describe the performance of a system they call *Fileprints* [36]. The system models file types with the mean and standard deviation of byte value frequency. Li et al. design *Fileprints* to handle byte value  $n$ -grams, but determine that 1-grams are sufficiently complex to accurately classify files. Additionally, a 1-gram file footprint (a *fileprint*) contains only 256 elements, whereas a 2-gram fileprint requires 256 times the storage space. Li et al. find the 1-gram fileprint performance sufficient, especially considering the low storage requirement advantages.

The *Fileprints* test corpus consists of five general file types: EXE (including DLL files), GIF, JPEG, DOC (including Word, Powerpoint and Excel files), and PDF. Li et al. consider three model types. Their *single-centroid* model combines each file type's training examples into one fileprint per type. A *multi-centroid* model consists of multiple models

for each file type. *K*-means clustering builds *K* fileprints per type. The third model type uses individual training examples as fileprints. Therefore, if *n* training samples belong to file type *t*, *Fileprints* assigns *n* models to file type *t*.

With both the single and multi-centroid models *Fileprints* finds average byte value frequencies over all training examples, then calculates the Mahalanobis distance to training samples to determine the closest training model. Li et al. give Mahalanobis distance as Equation 2.4, where *i* is byte value. Values  $x_i$  and  $\sigma_i$  are the mean frequency and standard deviation, respectively, for *i* in the training examples. Then,  $y_i$  represents *i*'s frequency in the test sample. Li et al. use  $\alpha$  as a smoothing factor, which becomes necessary when the standard deviation is 0. *Fileprints* classifies a test sample as the type of the closest training example. No standard deviation values exist for *Fileprints*' third model type, so Li et al. cannot use Mahalanobis distance, and use Manhattan distance instead.

$$D(x, y) = \sum_{i=0}^{n-1} \frac{|x_i - y_i|}{\sigma_i + \alpha} \quad (2.4)$$

*Fileprints*' accuracy on the five-way classification problem with the single-centroid model is 82%. With the multi-centroid model and individual-example models they find 89.5% and 93.8% accuracy, respectively. Li et al. find better performance when they truncate files. Truncation causes file header *magic numbers* to occupy a greater percentage of the total file. Li et al. truncate test and training files to include only the first 20 bytes, then apply *Fileprints* using the single-centroid model. This test achieves 98.9% accuracy.

Zhang and White apply a system similar to *Fileprints* to network traffic. They use their system to detect executables in network traffic [80]. Their extension to *Fileprints* examines traffic that represents only a portion of an executable. The researchers' goal is to use their system as an anomaly detection system sensor, and thus detect anomalous or hidden executables in network traffic.

### 2.3.2 Code Classification

Kolter and Maloof construct a system which classifies Windows executables as malicious or benign using a variety of machine learning techniques [35]. They experiment with boosted and un-boosted decision trees, SVMs, instance-based learners, and naive Bayes classifiers to determine the most effective technique for the classification problem. Kolter and Maloof perform pilot studies to determine the number of attributes,  $n$ -gram size, and number of bytes-per-gram that produce the most accurate results. They settle on 500 byte value 4-grams, and use these parameters for the remainder of their tests.

The researchers use information gain (IG) to determine which 4-grams best-characterize their corpus. IG provides a measure of the relevance of each 4-gram to the classification problem. IG yields larger values for features which appear more frequently in one class than another. Equation 2.5 gives a version of IG equivalent to Kolter and Maloof's. In it,  $g$  is a particular attribute (a 4-gram in this case) and  $C_i$  is the  $i$ th class (malicious or benign).  $P(g)$  is the proportion of training samples containing attribute  $g$ ,  $P(C_i)$  is the proportion of training samples in class  $i$ , and  $P(g, C_i)$  is the proportion of training samples of class  $i$  that exhibit attribute  $g$  (that contain the 4-gram  $g$  represents). Equation 2.5 then uses the presence or absence of a 4-gram to determine how well it contributes to the classification problem, and is also known as *average mutual information* [78].

$$IG(g) = \sum_{C_i} \left[ P(g, C_i) \log \left( \frac{P(g, C_i)}{P(g)P(C_i)} \right) + (1 - P(g, C_i)) \log \left( \frac{1 - P(g, C_i)}{(1 - P(g))P(C_i)} \right) \right] \quad (2.5)$$

Kolter and Maloof use machine learning techniques implemented in Weka [77]. Specifically, they use the J48, sequential minimal optimization, and AdaBoost.M1 algorithms for decision trees, SVMs and boosting, respectively. The J48 algorithm builds a binary tree with one 4-gram at each node, and branches representing presence or absence of that gram. J48 uses *gain ratio*, a measure similar to IG, to place each gram, then

prunes unhelpful branches to avoid overtraining [51]. Platt originally describes sequential minimal optimization, a tool which makes training SVMs efficient [49]. The Weka SVMs implementation solves multi-class problems through pairwise classification [77]. The AdaBoost algorithm boosts existing Weka classifiers by generating multiple classifier models, then weighting them based on performance.

Kolter and Maloof apply their classification system to a corpus of 1,971 benign and 1,651 malicious Windows executables. They find that the boosted decision tree and SVM classifiers perform best, with true positive rates exceeding 0.95 for false positive rates less than 0.05.

## 2.4 Statistical Measures

Typical definitions of statistical measures such as true positive rate, false positive rate, true negative rate and false negative rate work well for two-way classifiers. Equations 2.6, 2.7, 2.8, and 2.9 depict these measures, with values corresponding to the two-way classifier confusion matrix in Table 2.1. General  $n$ -way classifiers require more general statistical measures, and Equations 2.10, 2.11, 2.12, and 2.13 give these measures [61]. Values correspond to the  $n$ -way classifier confusion matrix in Table 2.2.

Table 2.1: Confusion matrix for a two-way classifier

|        |          | Prediction      |                 |
|--------|----------|-----------------|-----------------|
|        |          | negative        | positive        |
| Actual | negative | $samples_{n,n}$ | $samples_{n,p}$ |
|        | positive | $samples_{p,n}$ | $samples_{p,p}$ |



$$\text{true positive rate} = \frac{\text{samples}_{p,p}}{\text{samples}_{p,p} + \text{samples}_{p,n}} \quad (2.6)$$

$$\text{false negative rate} = \frac{\text{samples}_{p,n}}{\text{samples}_{p,p} + \text{samples}_{p,n}} \quad (2.7)$$

$$\text{true negative rate} = \frac{\text{samples}_{n,n}}{\text{samples}_{n,p} + \text{samples}_{n,n}} \quad (2.8)$$

$$\text{false positive rate} = \frac{\text{samples}_{n,p}}{\text{samples}_{n,p} + \text{samples}_{n,n}} \quad (2.9)$$

The true positive and true negative rate equations correspond with producer accuracy in the case of a 2-way classifier. Likewise, the false positive and false negative rate equations correspond with omission error. Producer accuracy is the percent of samples of  $class_i$  that the classifier identifies correctly as belonging to  $class_i$ . It is the likelihood that the classifier will identify an item correctly, given that it belongs to a specific class. Consumer accuracy is the percent of samples the classifier identifies as  $class_i$  that actually belong to  $class_i$ . It is the likelihood that a particular class's output correctly identifies a particular class.

Table 2.2: Confusion matrix for an  $n$ -way classifier

|        |           | Prediction             |                        |     |                        |
|--------|-----------|------------------------|------------------------|-----|------------------------|
|        |           | $class_1$              | $class_2$              | ... | $class_n$              |
| Actual | $class_1$ | $\text{samples}_{1,1}$ | $\text{samples}_{1,2}$ | ... | $\text{samples}_{1,n}$ |
|        | $class_2$ | $\text{samples}_{2,1}$ | $\text{samples}_{2,2}$ | ... | $\text{samples}_{2,n}$ |
|        | ...       | ...                    | ...                    | ... | ...                    |
|        | $class_n$ | $\text{samples}_{n,1}$ | $\text{samples}_{n,2}$ | ... | $\text{samples}_{n,n}$ |

$$\text{class } i \text{ producer accuracy: } PA_i = \frac{\text{samples}_{i,i}}{\sum_{m=1}^n \text{samples}_{i,m}} \quad (2.10)$$

$$\text{class } i \text{ omission error: } PE_i = \frac{\sum_{m=1}^n \text{samples}_{i,m} - \text{samples}_{i,i}}{\sum_{m=1}^n \text{samples}_{i,m}} = 1 - PA_i \quad (2.11)$$

$$\text{class } i \text{ consumer accuracy: } CA_i = \frac{\text{samples}_{i,i}}{\sum_{m=1}^n \text{samples}_{m,i}} \quad (2.12)$$

$$\text{class } i \text{ commission error: } CE_i = \frac{\sum_{m=1}^n \text{samples}_{m,i} - \text{samples}_{i,i}}{\sum_{m=1}^n \text{samples}_{m,i}} = 1 - CA_i \quad (2.13)$$

Equation 2.14 provides a rough measure of overall classifier accuracy. It yields the total percent of correctly identified samples.

$$\text{overall accuracy} = \frac{\sum_{m=1}^n \text{samples}_{m,m}}{\sum \text{samples}} \quad (2.14)$$

This chapter provided an overview of SCADA technology, describing system components, current threats, and attacks. It discussed firmware's function on PLCs, and the potential for firmware-based attacks. This chapter provided an overview of research related to this thesis, including work on firmware reversing, file carving, and malware identification. Chapter 3 describes the file carving and malware identification algorithms this research applies to firmware disassembly. It discusses this research's purpose and experimental methodology. Chapter 3 describes how this research assesses those algorithms, how it eases firmware disassembly, and how the research validates its results.

## 3 Methodology

### 3.1 Problem Definition

This research determines the effectiveness of a set of techniques which characterize, disassemble, and analyze firmware. It seeks to automate firmware analysis whether the vendor provides that firmware, an analyst forensically retrieves it from the contents of an EEPROM, or a security professional intercepts it after malicious third party modification. Therefore, the techniques this research develops must consider firmware in a generic sense. The ideal technique set makes no assumptions about vendor firmware layout decisions or header and footer contents. These parameters vary between vendors, devices, and firmware acquisition method.

The analysis process begins by separating a firmware into likely component segments and identifying the file types of those segments, then identifying the target architecture of code segments. Therefore, this research focuses on techniques capable of completing these two tasks. It evaluates three techniques which identify firmware file segments by file type, and two techniques that identify code segment target architectures. This research seeks to identify algorithms which provide the most accurate firmware segment decomposition and code architecture classification.

### 3.2 Approach

Figure 3.1 depicts the system under test, the *Firmware Disassembly System*. To disassemble firmware, a software system must uncompress compressed segments. It must identify component segment boundaries, then identify those segments' file type. The file type classifier identifies some segments with the *code* file type, and the software system must then classify those segments' architecture and endianness. Finally it must disassemble the binary code segments, resulting in correct assembly-language code output.

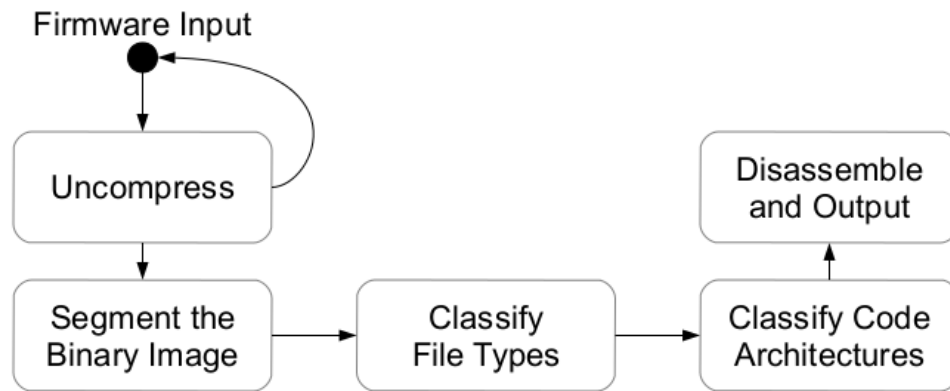

Figure 3.1: Block diagram of the Firmware Disassembly System

This research applies file carving algorithms to the file type identification problem, and applies malware identification algorithms to the code architecture identification problem. It evaluates each algorithm's accuracy when applied to firmware binaries or code segments respectively.

Each file carving algorithm classifies the file type of a segment of the binary image. The file carving algorithms do not segment the file themselves, and require a separate segmentation algorithm. This research considers two segmentation algorithms. Conti et al. solve the problem of segmenting binary files with a sliding window [15]. The sliding window is 1024 bytes wide with a step size of 512 bytes, and matches properties of their statistical classifier. This research considers file segmentation with a generalized version of the sliding window. The second file segmentation technique calculates an entropy value for each byte in a firmware based on a sliding window. It uses a segmented-least-squares algorithm to minimize the number of firmware sections, and to minimize the squared error of each section's mean entropy [34].

This research's first file type identification technique is Axelsson's [7]. He characterizes files with NCD, then associates them with file types from the training set using  $k$ -nearest neighbor. In the second technique, Li et al. perform  $n$ -gram analysis on

their training set to characterize file types, then use Mahalanobis distance to associate files with file types [36]. The third file carving technique characterizes file segments with four statistical signatures [15]. Conti et al. use  $k$ -nearest neighbor to associate members of their test set with file types. All three file carving algorithms perform classification for two or more classes.

Kolter and Maloof apply data mining techniques to malware detection and classification [35]. They collect 4-grams from executables, rank them by information gain, then select the top 500 as classifier attributes. They classify the resulting 4-gram set with seven algorithms. Their best results come from the boosted decision tree and SVM algorithms. This research uses the decision tree and SVM algorithms, with Kolter and Maloof's attribute selection technique, for code architecture identification.

Each algorithm requires a training set and a test set. The test and training sets for the file carving algorithms consist of firmware images and sets of files common to firmwares respectively. Training and test sets for the code classification algorithms consist of code segments common to firmwares, as Section 3.4 describes. Metadata describes the characteristics of each member in the test and training sets. The file carving algorithms and the code classification algorithms use supervised training, so training samples require metadata describing their file type, or code architecture and endianness. Testing the pipeline as a whole requires firmwares or pseudo-firmwares, and metadata describing their contents.

This research begins by training all classification algorithms with the appropriate training set and metadata. Next, classification techniques analyze their test sets without metadata. This research evaluates the performance of each algorithm by comparing its output to the test set metadata. This thesis reports and compares the accuracy of each classification technique.

### 3.3 System Boundaries

Figure 3.2 depicts the system under test as a set of inputs, outputs and components. Each component corresponds with a Figure 3.1 block. This research tests the components labeled CUT (Component Under Test).

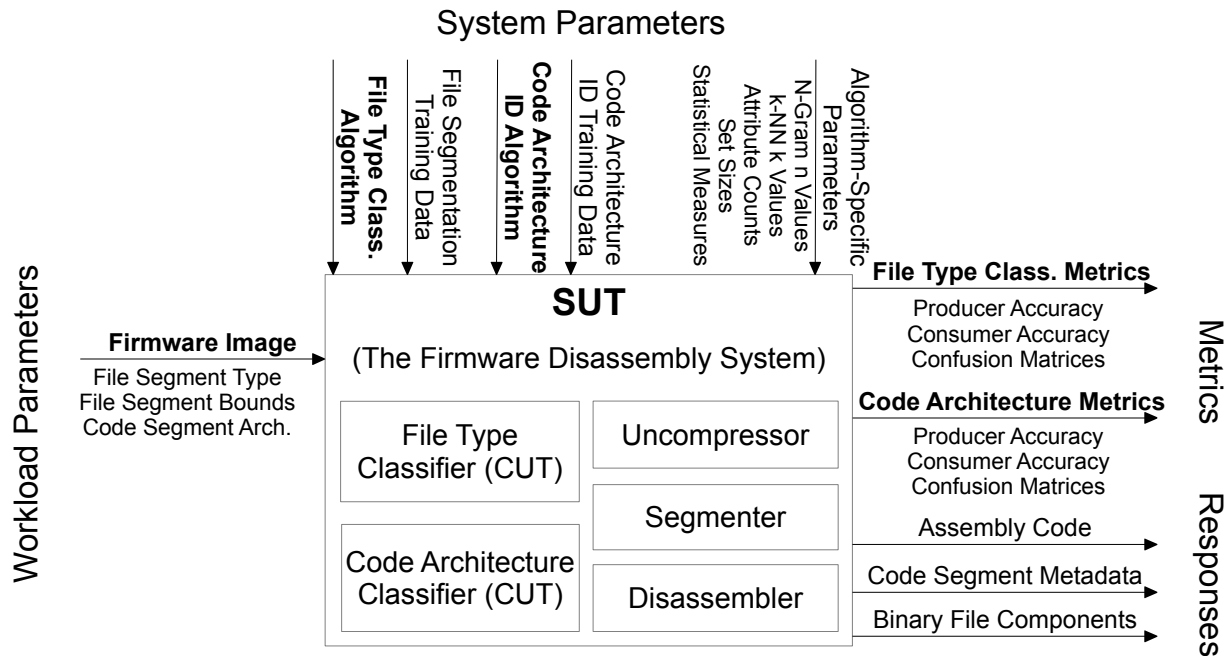

Figure 3.2: Firmware Disassembly System boundaries, inputs, and outputs

The Uncompressor and Disassembler components use standard compression and disassembly techniques. This research assumes that firmware uses standard compression techniques like Gzip [20], ZLib [21], and Lempel-Ziv-Markov chain algorithm (LZMA) [47]. The assumption greatly simplifies uncompression, and in practice vendors generally use standard compression techniques. The assumption rules out proper analysis of firmwares compressed with non-standard techniques, but the system's modularity allows future implementation of alternative compressions. The disassembler also uses existing disassembly algorithms, specifically, those implemented in the GNU Binutils project [26]. These system components already have proven performance, and the goal of this

research is to accurately provide those components with appropriate input, not to evaluate the accuracy of those components.

### 3.4 Workload

Binary firmware images are the Firmware Disassembly System's workload. Ideally, real firmwares would form the system's test set. To evaluate the system's results, however, the test set must include metadata that describes the firmware contents. Few PLC firmwares exist which meet that requirement. Therefore, the system must test pseudo-firmwares with known contents. Workload parameters characterize the pseudo-firmwares.

Real firmware images vary widely in composition. Simple PLCs may only require a firmware with one code segment. More complex PLCs with Ethernet interfaces may provide Web and FTP servers, and require larger firmwares that include file systems and multiple code segments. Many PLCs are modular, and contain several processors with potentially different architectures [58].

This research models firmware as a concatenation of multiple files of different types. With this model, three parameters characterize a pseudo-firmware. File segment type and bounds identify the file type of a set of bytes within a firmware image, and code architecture identifies the architecture of segments with the *code* file type. Analysis shows that real firmwares frequently include byte-padding for some segments, but this research does not pad pseudo-firmware segments. In practice, a simple padding-detection heuristic would increase system performance.

Analysis reveals that firmwares frequently include compiled code, compressed sections, images, HTML files, and even documentation. This research sources firmware file sections from the DigitalCorpora project [27]. This research uses only a fraction of the full one million file corpus, as Table 3.1 describes. The *Markup* file type includes HTML and Extensible Markup Language (XML) files. *Text* includes ASCII and UTF-8

encoded log files, character-delineated files (for instance, comma-separated value files), and documents represented in plain-text format.

Table 3.1: Characteristics of the test and training set file corpus

| <b>File type</b> | <b>Test Corpus<br/>File Count</b> | <b>Total Data (MB)</b> | <b>Average File Size (kB)</b> |
|------------------|-----------------------------------|------------------------|-------------------------------|
| GZip             | 441                               | 244.9                  | 568.7                         |
| JPEG             | 3489                              | 458.7                  | 134.6                         |
| PDF              | 1758                              | 1076.2                 | 626.9                         |
| Microsoft Word   | 2654                              | 1023.4                 | 394.9                         |
| Markup           | 12549                             | 808.8                  | 66.0                          |
| Text             | 3770                              | 1023.4                 | 278.0                         |
| PostScript       | 684                               | 1154.9                 | 1729.0                        |
| GIF              | 1477                              | 108.9                  | 75.5                          |
| ARM              | 8926                              | 1057.7                 | 121.3                         |
| Motorola 68000   | 13038                             | 1143.3                 | 89.8                          |
| AVR              | 13499                             | 1029.9                 | 78.1                          |
| PowerPC          | 9941                              | 1264.4                 | 130.2                         |

This research sources the code file types, ARM, Motorola 68000, AVR and PowerPC, from Debian Linux repositories serving those architectures. Debian repositories contain .deb files, a compressed archive format. GNU tools extract raw code sections from the .deb files to build this research's code file types. The Debian repositories contain little-endian ARM binaries, and big-endian AVR, Motorola and PowerPC binaries.

In constructing each pseudo-firmware, this research concatenates one random-sized segment from a random position in one file of each type. Each segment's maximum size



is a function of source file size. Specifically, the system avoids selecting bytes from the beginning and ending of source files to avoid file headers and footers. The system enforces a 1 kB minimum segment size when files are at least 1 kB, and includes the entire source file when files are smaller than 1 kB.

### 3.5 Performance Metrics

*File Type Classifier Metrics* measure the accuracy of the File Type Classifier component. Producer and consumer accuracy, and correspondingly omission and commission error, define file type classifier accuracy. Section 2.4 defines these statistics. These implicitly tie the performance of the file segmenter with that of the file type classifier. Producer and consumer accuracy quickly depict how accurately a multi-class classifier assigns classes, and how useful those assignments are to an analyst. Confusion matrices presenting these results enable detailed analysis of which classes are more difficult to classify correctly.

The component defines the file type of a binary file segment, thereby identifying the file type of a range of bytes. This research uses confusion matrices to describe the proportion of bytes assigned type  $X$  out of all bytes actually of type  $Y$ . The producer accuracy for a particular file type is the percentage of bytes in the input binary to which the component assigns the correct file type. The system considers bytes to which the component assigns no file type, or multiple types, incorrect. As a consequence of this definition, this metric penalizes segment classifications with incorrect bounds when the incorrect bounds hinder firmware analysis.

Similarly, this research uses confusion matrices to describe the proportion of bytes actually type  $Y$  out of all bytes assigned type  $X$ . The consumer accuracy for a particular type is the percentage of bytes assigned to a type  $X$  that are actually of type  $X$ . Again, the system considers bytes to which the component assigns no file type, or multiple types, incorrect.

The *Code Architecture Metrics* depicted in Figure 3.2 measure the accuracy of the *Code Architecture Classifier*. Code architecture metrics include the same metrics as the *File Type Classifier Metrics*. The metrics serve the same purpose, but apply to code architectures instead of file types. In practice, the *Code Architecture Classifier* relies on output of the *File Type Classifier*. This research evaluates the *Code Architecture Classifier* independently of the *File Type Classifier*, simulating ideal output of the *File Type Classifier*. For this reason, the *Code Architecture Classifier* must assign one and only one architecture to each input byte.

In addition to using producer and consumer accuracies to evaluate system component performance, this research uses them to evaluate the performance of the system as a whole. Confusion matrices again enable analysis of the system's misclassifications in detail.

### 3.6 Experimental Design

This research characterizes the *File Type Classifiers* and *Code Architecture Classifiers* independently, to determine their performance without the influence of potential classifier interactions. Within the system the *File Type Classifier* does not rely on the *Code Architecture Classifier*, but the *Code Architecture Classifier* relies on correct output from the *File Type Classifier*. This dependency may affect overall system performance.

Therefore, this thesis also characterizes the full system's performance. It simulates the *Firmware Disassembly System's* response to real-world stimulus by measuring its response to a synthetic workload. This research provides 95% confidence intervals for the synthetic workload accuracy data. Determining the accuracy of the components under test requires knowledge of the ideal component response, but extracting the characteristics of real PLC firmwares is difficult. Additionally, while manufacturer websites contain repositories of PLC firmware images, this research requires an order of magnitude more input files than images available. These issues preclude system classification using real-world firmwares.

This research uses the synthetic workload described in Section 3.4, and thus simulates the system's responses to real-world stimuli, to overcome the former problems.

After simulation, this research demonstrates result validity through measurement of the *Firmware Disassembly System*'s performance on a small validation set of real-world PLC firmwares. Validation also shows that, although the file types included in the test and training corpus are from firmware in general and are not specific to PLC firmwares, the results apply to PLC firmwares. Validation requires a smaller set of firmware images than system evaluation. Validation still requires knowledge of the ideal component responses, but the small set of firmwares required for validation makes manual analysis feasible.

### 3.7 System Implementation

The *Firmware Disassembly System* consists of Python 3 and C++ code. A graphical user interface (GUI), built with the cross-platform Tk framework, provides access to much of the system functionality. The *Firmware Disassembly System* executes on Windows and Unix-like operating systems, and requires no hardware more complex than a consumer-grade laptop.

The system relies on the Weka [77] machine learning tool, and uses its command line interface. Weka implements both of this research's code classification algorithms. With Weka's decision tree algorithm, *J48*, this research sets the *confidence factor* parameter to 0.25, sets the minimum number of instances per leaf to 2, and enables pruning. With the SVM algorithm, this research sets *complexity factor* to 1, and allows training data normalization. These are Weka's default parameter values.

The system also relies on the `python-statlib` [4] and `bitarray` [57] projects for implementations of simple statistics functions and efficient bit arrays. The system uses Python's Mersenne Twister pseudo-random number generator to generate all random values [50]. While the Mersenne Twister is not cryptographically secure, its long period makes it suitable for this project. The system uses GNU's `Binutils` to disassemble code sections.

Matasano Security's *deezee* tool, described by Peck and Peterson [48], motivates the *Firmware Disassembly System's* uncompression implementation.

### 3.8 Methodology Summary

This research characterizes algorithms from file carving and malware identification, as applied to PLC firmware reverse engineering. Figure 3.1 depicts the steps required for firmware reverse engineering, and consequently the blocks that form the *Firmware Disassembly System*. The system locates compressed sections within the firmware and uncompresses them, segments the firmware image into multiple byte ranges, then assigns a file type to each segment. The system then identifies the target architecture of all segments that contain processor instructions. Finally, it disassembles those code segments.

This research evaluates the *Firmware Disassembly System* via simulation. It evaluates the *Code Architecture Classifier* and *File Type Classifier* components independently, then evaluates the system as a whole.

System evaluation uses simulation to provide the large number of well-classified input files that statistical standards require. The simulation generates a synthetic workload composed of firmware images which match some characteristics of real-world PLC firmwares. Finally, this research characterizes real-world PLC firmwares to validate the experimental results.

## 4 Results and Analysis

This chapter presents and discusses this research effort's results. It considers the system in stages, first discussing the performance of file segmenting algorithms, followed by the performance of the file and code type classifiers. The chapter then analyzes the entire machine learning pipeline's accuracy on the test set.

Finally, the chapter discusses disassembly of real-world firmwares. It presents some side results important for the general firmware disassembly problem, then describes the disassembly of several firmwares. Finally, the chapter considers the research system's performance on real-world firmware.

### 4.1 File Segmenting Algorithms

This research considers two general file segmenting algorithms, and this section analyzes the performance of four variations on those algorithms. The first general algorithm is a generic sliding window with configurable window and step size. This section uses the term *Sliding Window* to refer to this most generic case. The *Even Divisions* algorithm refers to a sliding window with window size such that it breaks a file into a configurable number of segments. *Even Divisions* uses a step size equal to the window size.

The second general algorithm chooses segments based upon regions of constant entropy. Specifically, the *Segmented-Least-Squares* algorithm uses segmented-least-squares to choose segments in order to minimize both mean-squared-error and segment count. Unfortunately, the segmented-least-squares dynamic programming algorithm is of  $O(n^3)$  complexity. To achieve analysis run times less than a day on firmwares greater than 500 kB, this section's *Segmented-Least-Squares* algorithm uses the Douglas-Peucker algorithm as an initial filter on the entropy values [22]. The Douglas-Peucker algorithm reduces a set of points while maintaining some of the original shape. This section also

considers the performance of the *Douglas-Peucker* algorithm alone at reducing entropy values to a set of sections.

The file segmenter test set consists of a set of pseudo-firmwares containing a total of 120 segments, and comprising 8 MB. Figure 4.1 provides a performance overview of the file segmenting algorithms. The segment and code type classifiers require time to run, and the time to classify all segments increases approximately linearly with the number of segments. Therefore an appropriate file segmenting algorithm must accurately find file segments without introducing too many segments. Thus, Figure 4.1 compares file segmenter root mean square error (RMSE), and the ratio of segments yielded to actual.

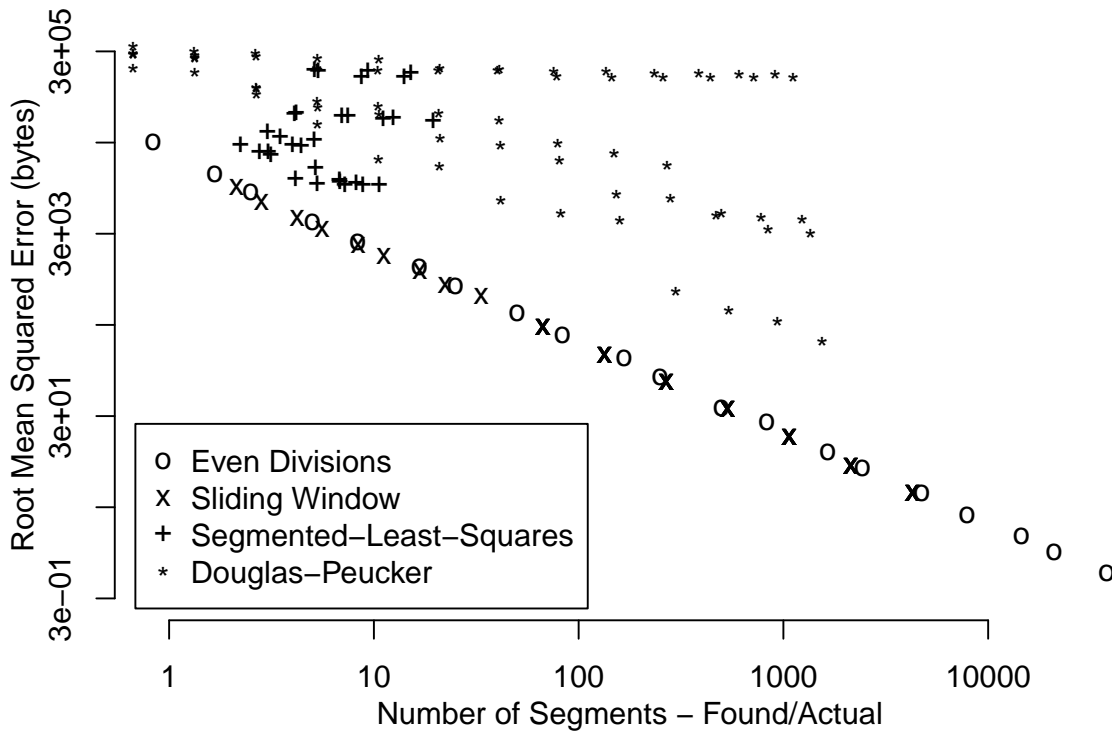

Figure 4.1: File segmenter performance

Both general sliding window algorithms perform similarly, and produce the best tradeoff between segment ratio and error. In no case did the entropy algorithms produce an

error better than the general sliding window algorithms at a similar segment ratio. Table 4.1 shows the relationship between algorithm parameters and error for both sliding window algorithms. The performance of *Sliding Window* depends only upon step size and not upon window size, due to the definition of error in this test. Thus, the table does not contain window size. In practice the window size must be at least as large as the step size, or the sliding window will skip bytes between windows.

Table 4.1 only displays configurations which yield between 100 and 12,000 segments for the 120 segment input, as indicated by found-to-actual segment ratios between 0.833 and 100. Configurations with found-to-actual ratios less than 1 cannot provide enough information for the file type classifier to identify all component files, and must provide an analyst with incomplete results. Found-to-actual ratios greater than 100 cause firmware analysis times to exceed 20 minutes, and are therefore unreasonable in practice.

Table 4.2 compares the performance of *Douglas-Peucker* and *Segmented-Least-Squares*. It contains results of the tests with the best RMSE for each value of *Num. Segments*. *Segmented-Least-Squares* only has *Num. Segments* values up to  $2^{13}$  due to run time limitations. The algorithm's  $O(n^3)$  nature causes larger values of the parameter to require firmware analysis times exceeding one hour.

The *Num. Segments* parameter specifies an approximate number of points for the Douglas-Peucker algorithm to output, whether it's acting as a filter for *Segmented-Least-Squares* or on its own. For *Douglas-Peucker* an increase in this parameter value corresponds with an increase in the the number of segments it yields. In general, this statement holds for *Segmented-Least-Squares* too, because an increase in the parameter gives the algorithm more points to consider, and therefore more potential segments. In the case of *Num. Segments* values  $2^8$  and  $2^{11}$ , however, this statement does not hold. An interaction with the *Window Size* parameter causes *Segmented-Least-Squares* to yield more segments than with larger *Num. Segments* parameter values.

Table 4.1: Performance vs. parameter value for the sliding window algorithms

| Algorithm      | Parameter     | Value | RMSE  | Segments     |
|----------------|---------------|-------|-------|--------------|
|                |               |       |       | Found/Actual |
| Sliding Window | Step Size     | 1024  | 288   | 66.8         |
|                |               | 2048  | 616   | 33.4         |
|                |               | 3072  | 824   | 22.3         |
|                |               | 4096  | 1171  | 16.7         |
|                |               | 6144  | 1725  | 11.2         |
|                |               | 8192  | 2263  | 8.39         |
|                |               | 12288 | 3369  | 5.60         |
|                |               | 16384 | 4489  | 4.22         |
|                |               | 24576 | 6777  | 2.83         |
|                |               | 32768 | 9742  | 2.13         |
| Even Divisions | Num. Segments | 1000  | 234   | 83.3         |
|                |               | 600   | 411   | 50.0         |
|                |               | 300   | 802   | 25.0         |
|                |               | 200   | 1288  | 16.7         |
|                |               | 100   | 2462  | 8.33         |
|                |               | 60    | 4001  | 5.00         |
|                |               | 30    | 8667  | 2.50         |
|                |               | 20    | 13732 | 1.67         |
|                |               | 10    | 30759 | 0.833        |

Both general sliding window algorithms execute quickly. They perform segmentation in under one second for all cases in Table 4.1. Indeed, they only need to determine the



Table 4.2: Performance vs. parameter value for the entropy algorithms

| Algorithm               | Num. Segments   | Window Size | RMSE   | Segments Found/Actual |
|-------------------------|-----------------|-------------|--------|-----------------------|
| Douglas-Peucker         | 2 <sup>5</sup>  | 2048        | 100909 | 2.67                  |
|                         | 2 <sup>6</sup>  | 2048        | 47767  | 5.31                  |
|                         | 2 <sup>7</sup>  | 2048        | 19506  | 10.5                  |
|                         | 2 <sup>8</sup>  | 2048        | 16374  | 20.9                  |
|                         | 2 <sup>9</sup>  | 2048        | 6936   | 41.6                  |
|                         | 2 <sup>10</sup> | 2048        | 5045   | 82.0                  |
|                         | 2 <sup>11</sup> | 2048        | 4214   | 159                   |
|                         | 2 <sup>12</sup> | 2048        | 701    | 298                   |
|                         | 2 <sup>13</sup> | 2048        | 437    | 541                   |
|                         | 2 <sup>14</sup> | 2048        | 332    | 937                   |
|                         | 2 <sup>15</sup> | 2048        | 198    | 1548                  |
| Segmented-Least-Squares | 2 <sup>8</sup>  | 1024        | 21535  | 3.13                  |
|                         | 2 <sup>9</sup>  | 2048        | 23435  | 2.77                  |
|                         | 2 <sup>10</sup> | 2048        | 23576  | 3.05                  |
|                         | 2 <sup>11</sup> | 512         | 11631  | 6.80                  |
|                         | 2 <sup>12</sup> | 2048        | 10524  | 5.28                  |
|                         | 2 <sup>13</sup> | 512         | 10110  | 10.6                  |

size of the test firmware to perform segmentation, which is a speedy task on modern operating systems. In contrast, *Douglas-Peucker* requires approximately 900 seconds to complete segmentation for the test set. *Segmented-Least-Squares* requires approximately 8000 seconds in the lowest error test cases, or 3000 in next-lowest error cases.

This research selects *Even Divisions* as the best file segmenting algorithm of those it tests, and uses this algorithm for the remainder of the research. The general sliding window algorithms make the best error/segment ratio tradeoff, and run fastest. Additionally, the *Even Divisions* parameter is linearly proportional to run time, and provides users with a simple tradeoff between accuracy and computation time. Large values of the parameter (or small input firmwares) may result in segments inappropriately small for the file type and code classifiers, so this research enforces a minimum segment size of 512 B. This research also uses 100 for the *Num. Segments* parameter, because it provides a reasonable balance between run-time and accuracy for the available firmwares.

## 4.2 Classifier Analysis

Each classifier builds models to describe the training set. During testing they compare test samples to the models to determine which model best-matches the sample. The internal representation of the model differs by classifier, but each model must represent properties inherent to the files it represents. The support vector machine (SVM) classifier model is a set of weights for a neural network, and the model itself yields little insight into the classifier performance. This section discusses the properties revealed by the classifier models, but skips discussion of the SVM classifier. This section builds classifier models from the training corpus. Table 4.3 describes the training corpus, which is 80% of the full corpus as described by Table 3.1.

### 4.2.1 Fileprints

Fileprints represents file types as a byte-value mean frequency and variance. This section graphs and discusses the fileprints of several file types, as generated from the training set comprising 80% of the file corpus. Each graph represents byte values on the X-axis and presents the mean proportion of each byte in the training files and that value's variance. Each graph depicts variance on a logarithmic-scale Y-axis.

Table 4.3: Training set characteristics

| File type      | File Count | File type      | File Count |
|----------------|------------|----------------|------------|
| GZip           | 352        | PostScript     | 547        |
| JPEG           | 2791       | GIF            | 1181       |
| PDF            | 1406       | ARM            | 7140       |
| Microsoft Word | 2123       | Motorola 68000 | 10430      |
| Markup         | 10039      | AVR            | 10799      |
| Text           | 3016       | PowerPC        | 7952       |

Figure 4.2 provides a reference, and is the fileprint of a set of 100 files containing 100 kB of uniformly-distributed random byte values. The expected average byte frequency for this distribution is  $1/256 = 0.39\%$ , and Figure 4.2 shows that this expectation holds in practice. Additionally, the random distribution has a small, flat variance profile.

GZip and Joint Photographic Experts Group (JPEG)'s fileprints are not visually similar. Figure 4.3 shows GZip's byte value peaks have a periodic nature, with major peaks at bytes 127, 63, 191, and 255, and smaller peaks on every eighth byte. However, these byte frequency peaks correspond with peaks on a variance plot that is already, generally, ten times that of the random distribution. JPEG has no noticeable periodic nature, as Figure 4.4 depicts. It has only one major peak (besides the maximum and minimum byte values), at byte 32. The JPEG fileprint also shows relatively large variance. Similarly, the fileprints for Microsoft Word files and Portable Document Formats (PDFs) show relatively large variance. Section 4.3.1 discusses the implications of this fact.

Figures 4.5 and 4.6 show that the Text and PostScript fileprints are visually similar. Both possess similar variance distributions. However, the smallest variance values in the Text fileprint indicate that some byte values were not present in any text files, and the PostScript fileprint shows no such case. The largest byte frequency peak in both is at byte

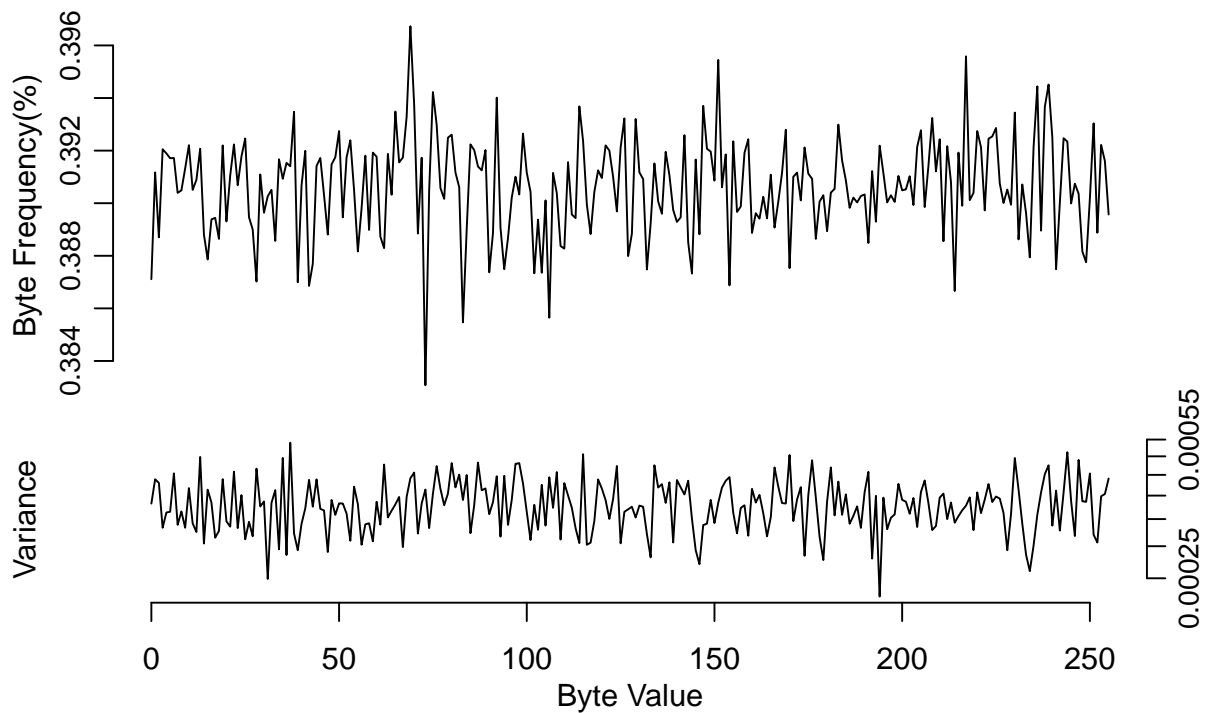

Figure 4.2: Fileprint of random files

32, the American Standard Code for Information Interchange (ASCII) representation of a space. Both fileprints show that bytes 44 through 57 and 97 through 117 occur frequently, and these correspond to the ASCII representations of punctuation, the numbers, and most of the lowercase alphabet.

Figure 4.7 show that Graphics Interchange Format (GIF) file byte frequency has a periodic nature. Bytes divisible by four present more frequently, a result similar to that of GZip files in Figure 4.3. This is because GIF images use Lempel-Ziv-Welch (LZW) compression, an algorithm similar to GZip compression [14]. Figure 4.8 depicts the code training files fileprint, pooling all code architectures. The code fileprint peaks correspond with bytes present in the decision tree classifiers' most frequently used leaves. Notably, bytes `0x40`, `0x4E`, and `0x80` correspond to the peaks at 64, 78, and 128 respectively, and Section 4.2.4 indicates that these bytes appear frequently in decision tree leaves.

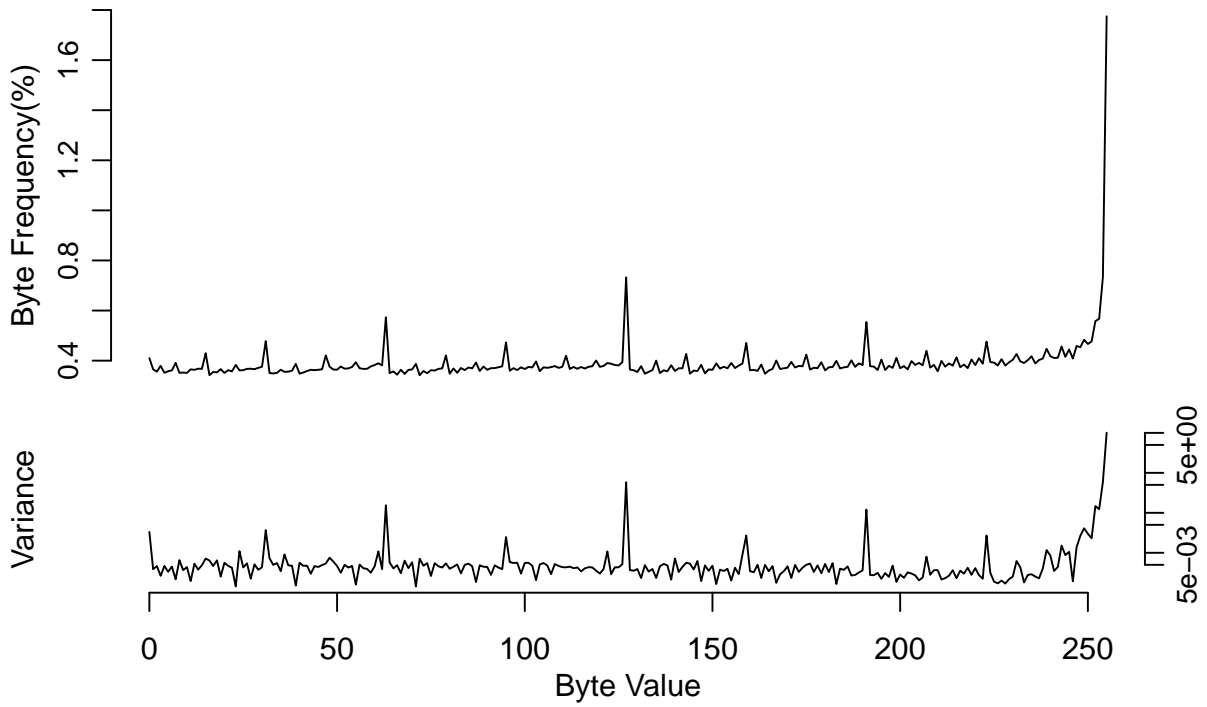

Figure 4.3: Fileprint of GZip training files

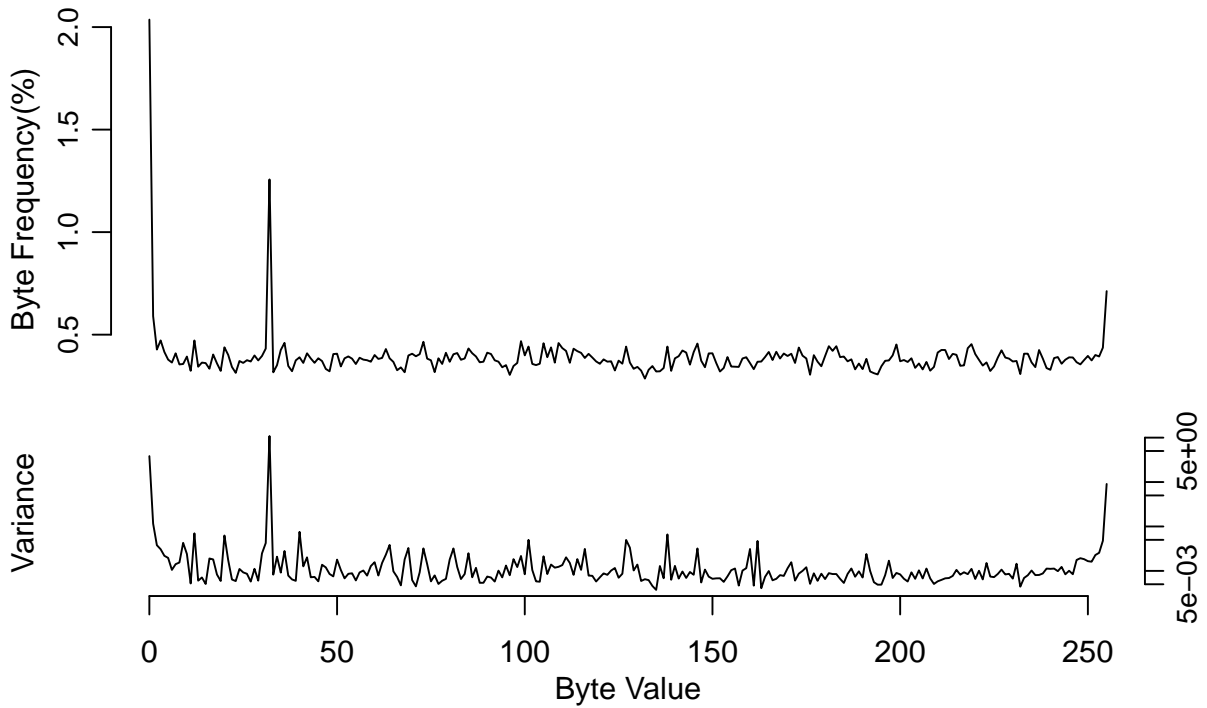

Figure 4.4: Fileprint of JPEG training files

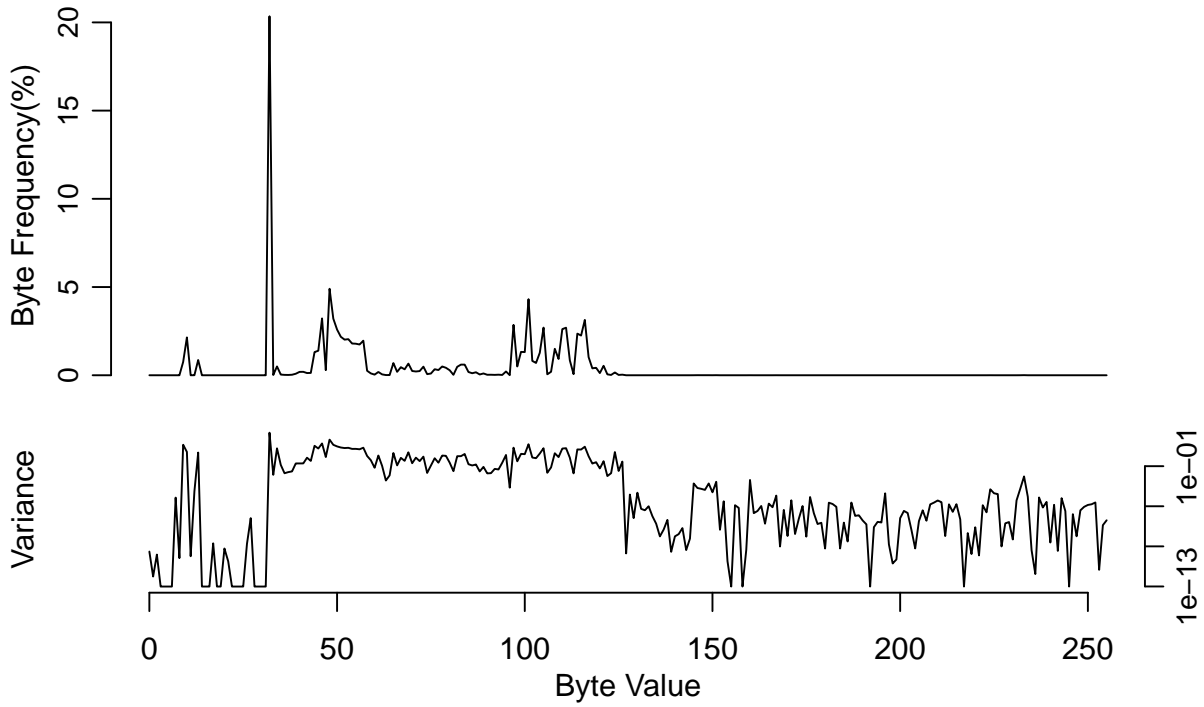

Figure 4.5: Fileprint of Text training files

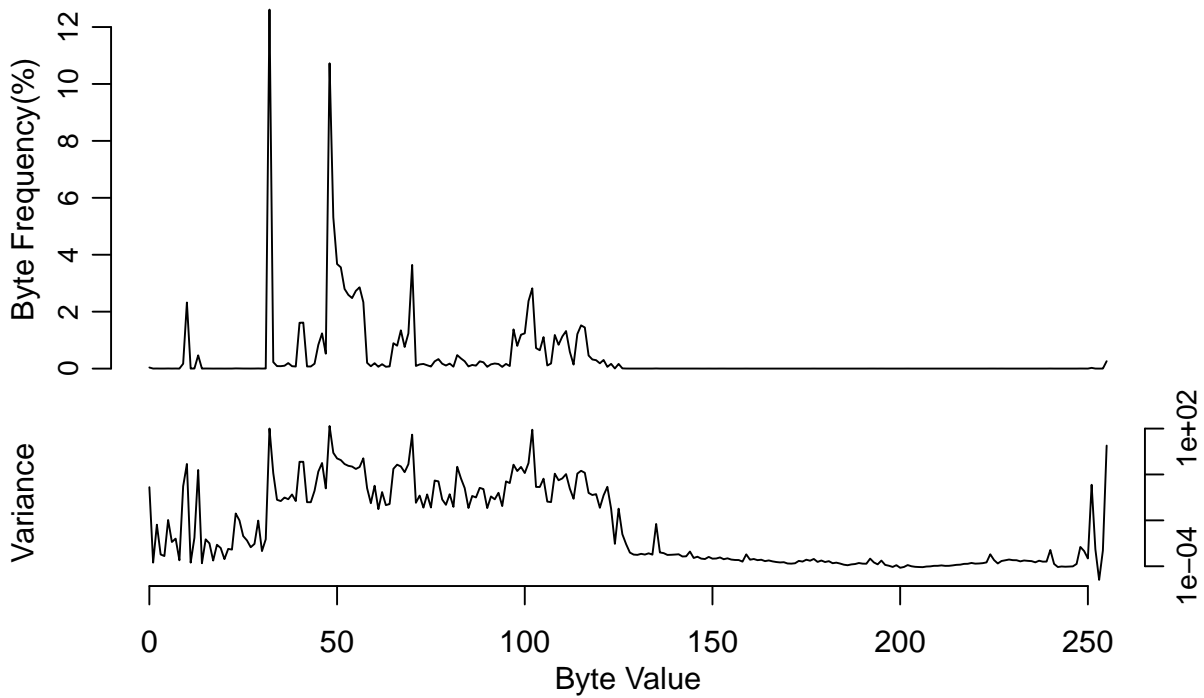

Figure 4.6: Fileprint of PostScript training files

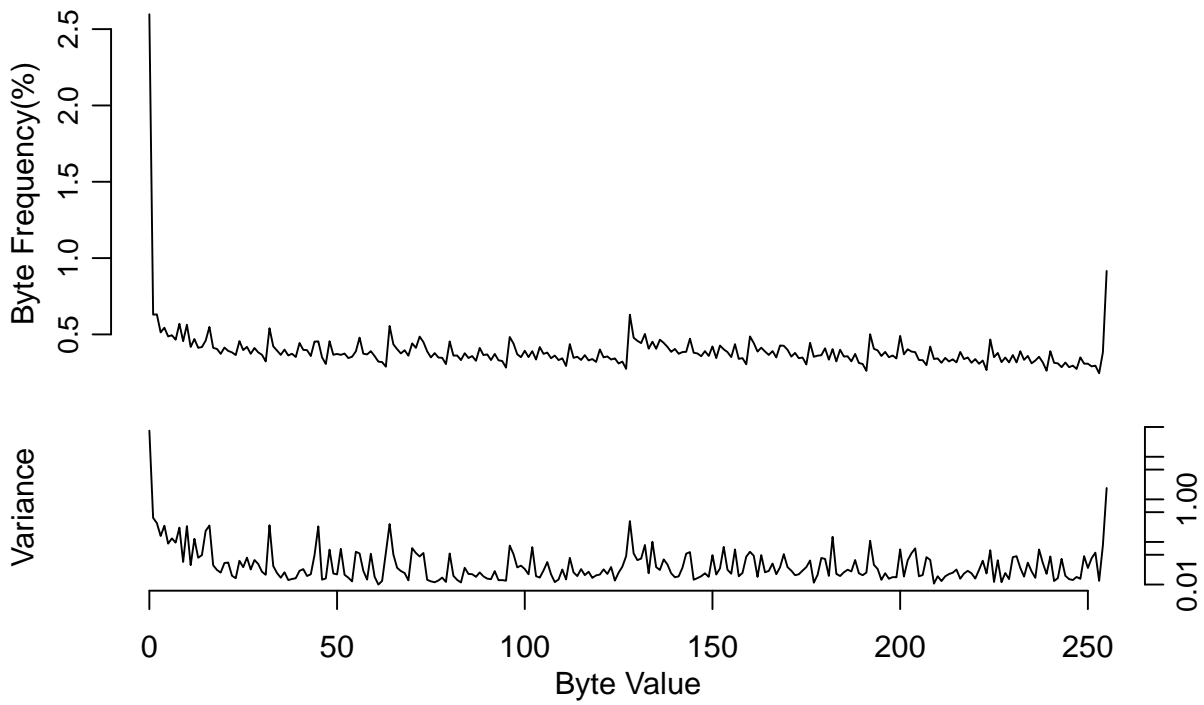

Figure 4.7: Fileprint of GIF training files

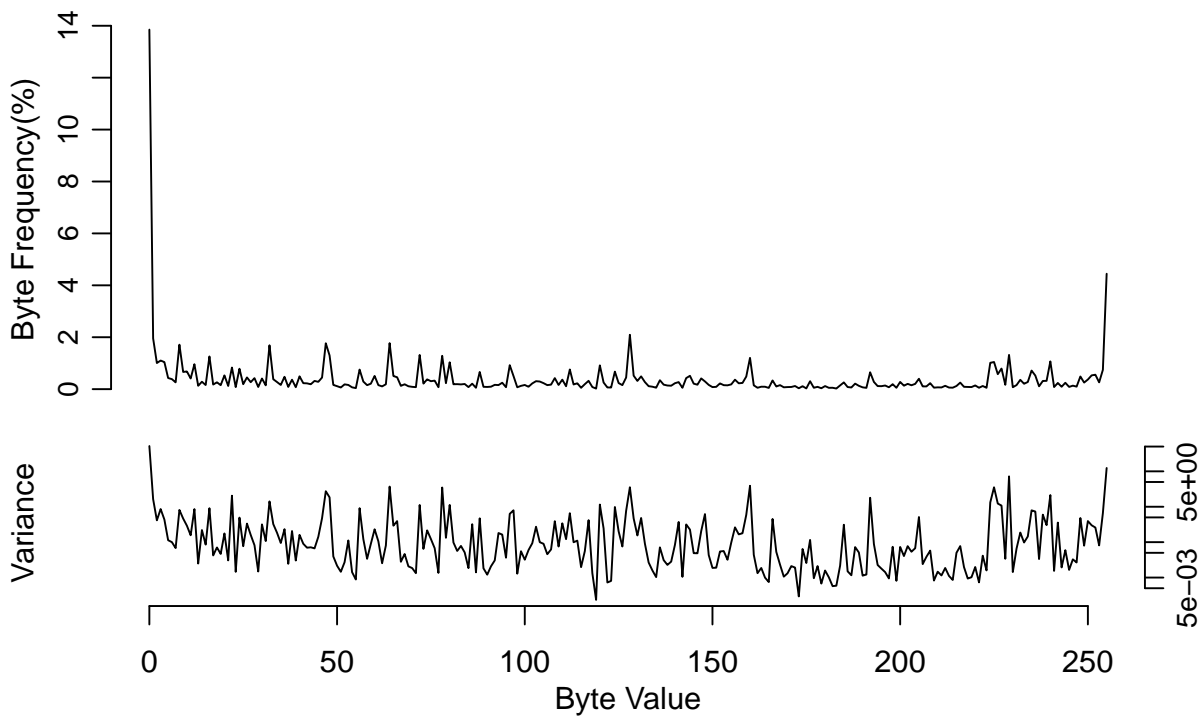

Figure 4.8: Fileprint of code training files

#### 4.2.2 Statistical

Figure 4.9 displays the normalized model parameters of Conti’s statistics-based classifier, as applied to this research’s training data. Ideally, all file types have values distinct enough to enable the classifier to distinguish between each with Euclidean distance. Visually however, the *GZip*, *JPEG*, *PDF*, and *GIF* file types form one cluster, while the *Microsoft Word*, *Markup*, *Text*, and *PostScript* file types form a second. This suggests that the statistical classifier will have difficulty distinguishing between these clustered types.

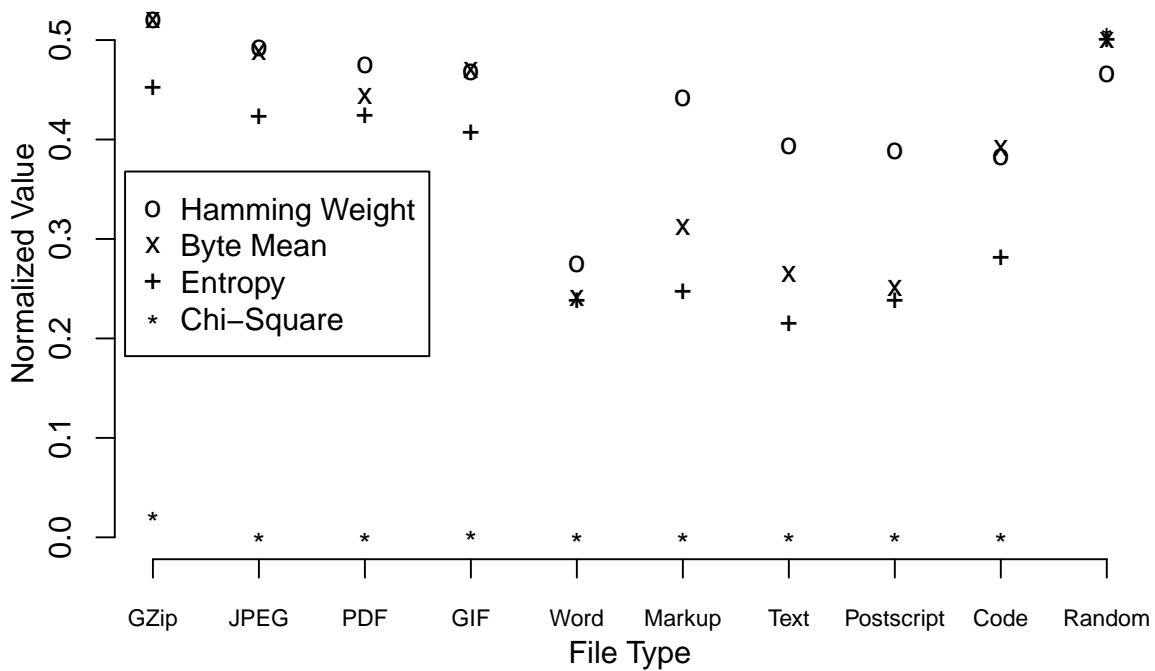

Figure 4.9: Statistical classifier model

Data comprising the *Random* file type come from a uniform distribution over all byte values. Figure 4.9 provides the *Random* file type for comparison only, and shows the effect of parameter normalization. The uniform distribution suggests that the average byte value



should approximate 0x80, and it does in practice. Additionally, random values should, and do, have the highest entropy and chi-square values.

The *Microsoft Word, Markup, Text, PostScript* and *Code* file types have lower mean byte values and entropies than the other types. *Word*'s hamming weight value differs significantly from all other file types, suggesting that the classifier will have success distinguishing its type. Unfortunately, the variance of the *Word* values is 10 times that of the other file types. This indicates that these values vary more significantly between training samples. The classifier may still have difficulty separating *Word* files from the rest because it uses *k*-Nearest Neighbor (*k*-NN) with training samples. The *Code* file type has a greater byte mean value than the other clustered types, suggesting that the classifier has a method for distinguishing *Code* segments.

*GZip, JPEG, PDF* and *GIF* have similar values for all parameters. Their entropy values compare to the *Random* file type, and show that these file types contain more information than the others. The similarity of these types' parameters suggest that the classifier will confuse these types easily.

All chi-square values in Figure 4.9, except *Random*, are 0.02 or smaller. A non-zero chi-square value indicates that the byte values are distributed nearly randomly. The figure's values indicate that all file types in the training set are significantly different from random. This result suggests that the chi-square measure provides little information upon which the classifier might base a decision.

### **4.2.3 Normalized Compression Distance**

This research trains the normalized compression distance (NCD) classifier on 10% of the training corpus due to the time constraints discussed later in Section 4.3.3. Axelsson's NCD classifier has little model to discuss, because it calculates little in advance. The classifier calculates the compression length of training samples in advance, and Table 4.4 presents a summary of those values. The smallest and largest training sample compression

distances are 29 B and 1047 B respectively, and they belong to a code sample and a PostScript sample respectively.

Many values in the Table 4.4 are similar, for instance, the mean compression length of Microsoft Word and Text samples. This is not cause for concern because NCD bases classification on a comparison of compression length of test and training samples individually, to compression length of concatenated test and training samples. Equation 2.1 describes the comparison.

The classifier uses GZip compression, and selects multiple 1 kB disjoint sections from training samples. When training samples are smaller than 1 kB, the classifier selects only one section comprising the entire sample. Table 4.4 indicates that the compression algorithm increases the length of GZip and GIF samples, and does not substantially decrease the length of JPEG samples. This result is reasonable because compressed data comprises the majority of files within those file types.

Table 4.4: NCD classifier training corpus model statistics

|                | <b>Mean Length</b> | <b>Standard Deviation</b> |
|----------------|--------------------|---------------------------|
| GZip           | 1043.2             | 25.4                      |
| JPEG           | 1015.9             | 132.1                     |
| PDF            | 921.8              | 255.7                     |
| Microsoft Word | 430.0              | 305.0                     |
| Markup         | 450.2              | 120.4                     |
| Text           | 437.7              | 126.2                     |
| PostScript     | 397.3              | 173.1                     |
| GIF            | 1025.6             | 112.9                     |
| Code           | 649.9              | 146.9                     |

Table 4.4 also indicates that Microsoft Word documents have the largest standard deviation in compression size. Word documents may contain other file formats, like GIF and JPEG. Word documents that consist largely of those file types compress little.

The largest compression length is 1047 B, and 11% of training samples compress to this length. The smallest compression length is 29 B, and 0.5% of training samples compress to this length. Samples from all types compressed to these distances. These results suggest that the classifier may have difficulty, and that future iterations of the research should consider selecting longer training data sections.

#### **4.2.4 Decision Tree**

Figure 4.10 depicts the decision tree classifier's model. The trained decision tree contains only 15 leaves, indicating that it is unlikely to have over-fit the data. Its size also suggests that information gain (IG) feature selection results in a feature set which characterizes the training set well.

Notably, 99.8% of the AVR samples (all but 24 of 10799) contain the byte string `0xEBCD4040`, and no code for other architectures contains this string. This byte string is the most frequently used leaf in the decision tree. The string corresponds to an relative jump followed by a subtraction from register `r20`. The byte string occurs as the first four bytes, and again throughout, most of the AVR files.

The second most frequently used leaf is where byte string `0x0000004E` is present, and the tree classifies files as Motorola 68000 in that case. This decision path captures 95.9% of Motorola 68000 samples, all but 427 of 10430. Binaries in the corpus frequently contained this byte string as the result of a jump, then a register OR with `0x00` (effectively a no-operation instruction), then a jump.

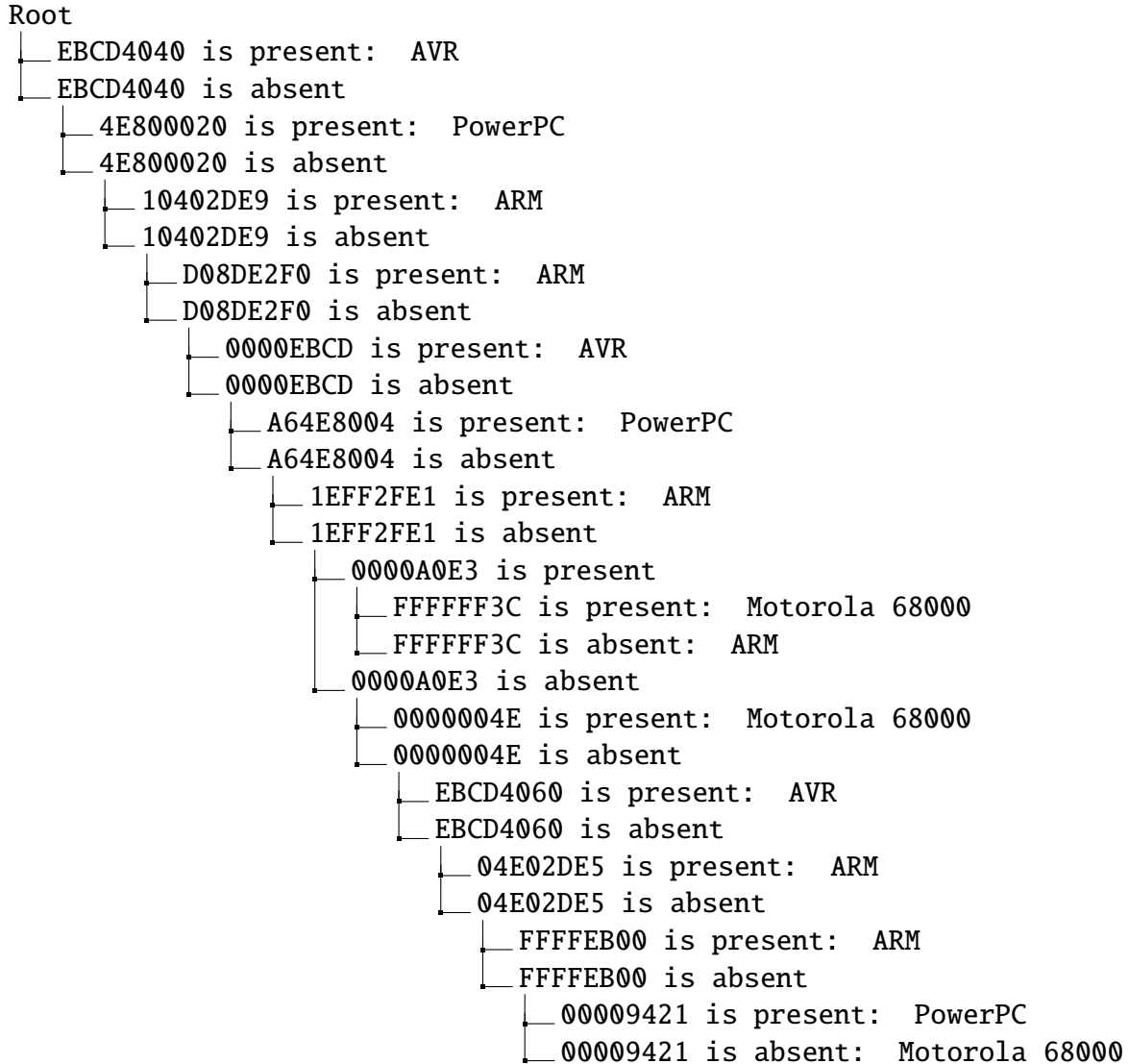

Figure 4.10: Decision tree classifier model

The decision tree's third most frequently used leaf is where string `0x4E800020` is present, classifying a sample as PowerPC. The classifier uses this leaf for 99.3% of PowerPC samples, all but 57 of 7952. The byte string corresponds with the PowerPC `blr` opcode. The opcode branches to the address in the *link register*, unconditionally. PowerPC code generally places the return address for a subroutine in the link register, making `blr` effectively a *return* statement [30].

Figure 4.10 classifies 91.1% of ARM binaries (all but 632 of 7140) with leaf `0x10402DE9`, the tree's fourth most frequently used leaf. This byte string corresponds with

a push, placing the contents of both register four and the link register on the stack. This byte string frequently occurs in the function preamble, pushing those register contents, only to pop them before returning from the function. The link register, specifically, contains the return address for the function. ARM code frequently executes a branch to the link register contents immediately after retrieving them with a pop.

Figures 4.11 and 4.12 depict the decision tree leaf use on the training and test sets respectively. Each dot represents a leaf node, and dot area corresponds to the number of samples the classifier assigns to that leaf as Table 4.5 gives. Each dot's caption specifies the leaf node byte string, and whether the leaf corresponds to the presence or absence of that byte string with the letters *p* and *a* respectively. The largest dots correspond with the leaves this section discusses. Corresponding dots in both diagrams are less than 0.2% different, indicating that the decision tree's performance on both sets is similar. The research randomly assigns the test and training corpus from a larger corpus. Similar dot size indicates that, for both test and training corpus, random assignment selects similar proportions of files characterized by each decision tree branch.

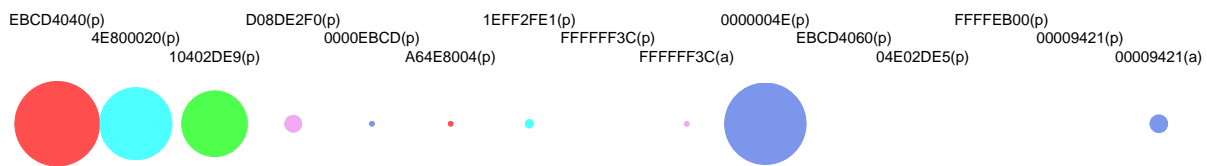

Figure 4.11: Decision tree leaf use on the training set

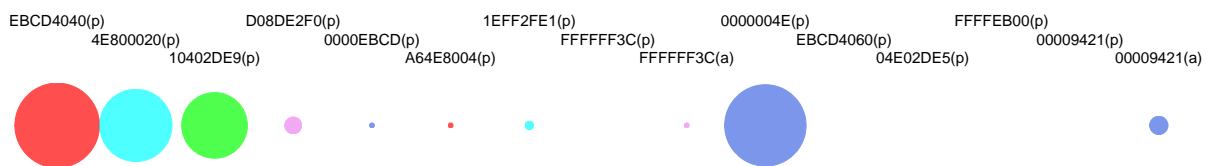

Figure 4.12: Decision tree leaf use on the test set

Table 4.5: Decision tree leaf use on the test and training set

| Leaf               | Training | Test | Leaf               | Training     | Test        |
|--------------------|----------|------|--------------------|--------------|-------------|
| EBCD4040 (Present) | 10775    | 2020 | FFFFFF3C (Absent)  | 38           | 5           |
| 4E800020 (Present) | 7898     | 1477 | 0000004E (Present) | 10005        | 1878        |
| 10402DE9 (Present) | 6509     | 1220 | EBCD4060 (Present) | 2            | 0           |
| D08DE2F0 (Present) | 437      | 81   | 04E02DE5 (Present) | 10           | 1           |
| 0000EBCD (Present) | 19       | 5    | FFFFEB00 (Present) | 8            | 2           |
| A64E8004 (Present) | 24       | 5    | 00009421 (Present) | 2            | 1           |
| 1EFF2FE1 (Present) | 104      | 25   | 00009421 (Absent)  | 488          | 95          |
| FFFFFF3C (Present) | 2        | 0    | <b>Total</b>       | <b>36321</b> | <b>6815</b> |

### 4.3 Classifier Accuracies

This section presents the results of executing each classifier independently. Table 4.6 describes the test set for the file type classifiers. The test set consists of files from the full file corpus, which Table 3.1 describes. The test set comprises 15% of corpus files from each file type, and the training set, described by Table 4.3, comprises another 80% of the corpus files from each type. A cross-validation set comprises the remaining 5% of corpus files, and is excluded from the training and testing sets. The test, training, and cross-validation sets are mutually disjoint.

#### 4.3.1 Fileprints

Table 4.7 depicts the Fileprints classifier producer accuracies. Highlighted cells in the confusion matrix indicate correct matches. Fileprints' overall accuracy, for this test set, is 71.3%. Fileprints performs better on this system's critical file types, the *Code* file types. For these types the overall accuracy is 95.6%. Accuracy on non-*Code* file types is 52.5%.

Table 4.6: Test set characteristics

| File type      | File Count | Total Data (MB) | Average File Size (kB) |
|----------------|------------|-----------------|------------------------|
| GZip           | 67         | 32.9            | 502.4                  |
| JPEG           | 524        | 49.0            | 95.8                   |
| PDF            | 265        | 163.3           | 630.9                  |
| Microsoft Word | 399        | 140.8           | 361.3                  |
| Markup         | 1883       | 142.9           | 77.7                   |
| Text           | 566        | 145.6           | 263.4                  |
| PostScript     | 103        | 190.8           | 1897                   |
| GIF            | 223        | 16.7            | 76.8                   |
| ARM            | 1340       | 153.9           | 117.6                  |
| Motorola 68000 | 1957       | 170.2           | 89.1                   |
| AVR            | 2026       | 148.9           | 75.2                   |
| PowerPC        | 1492       | 209.7           | 143.9                  |

The system passes *Code* sections on to a further classifier, so *Code* file type accuracy during the file type classification stage is critical.

Table 4.7 reveals that Fileprints performs poorly with *PDFs*, classifying them as *GZip* or *JPEG* in 71.5% of test cases. Random file type assignment results in an expected producer accuracy of 11.1% in this test. In all cases except *PDF* Fileprints performs better than simple random assignment. Fileprints also performs poorly when classifying *Text* files, ascribing the *PostScript* type in 64.6% of test cases.

Fileprints performs relatively well on *JPEG* and *GZip*, but Fileprints' most common misclassification on these file types is to swap them. Table 4.7 indicates that Fileprints

Table 4.7: Producer accuracy confusion matrix for the Fileprints classifier

|        |                | Prediction |      |      |                |        |      |            |      |      |
|--------|----------------|------------|------|------|----------------|--------|------|------------|------|------|
|        |                | GZip       | JPEG | PDF  | Microsoft Word | Markup | Text | PostScript | GIF  | Code |
| Actual | GZip           | .942       | .034 | .000 | .000           | .000   | .000 | .000       | .022 | .001 |
|        | JPEG           | .155       | .763 | .002 | .008           | .003   | .005 | .000       | .058 | .006 |
|        | PDF            | .438       | .277 | .090 | .003           | .020   | .052 | .052       | .063 | .006 |
|        | Microsoft Word | .300       | .097 | .000 | .408           | .112   | .010 | .001       | .052 | .020 |
|        | Markup         | .000       | .000 | .000 | .000           | .808   | .130 | .061       | .000 | .000 |
|        | Text           | .000       | .000 | .000 | .000           | .124   | .230 | .646       | .000 | .000 |
|        | PostScript     | .000       | .000 | .000 | .001           | .039   | .129 | .831       | .000 | .000 |
|        | GIF            | .066       | .045 | .001 | .003           | .000   | .000 | .000       | .875 | .009 |
|        | ARM            | .003       | .000 | .000 | .003           | .000   | .000 | .000       | .000 | .993 |
|        | Motorola 68000 | .000       | .000 | .000 | .015           | .000   | .000 | .000       | .001 | .984 |
|        | AVR            | .007       | .001 | .003 | .067           | .007   | .004 | .001       | .048 | .862 |
|        | PowerPC        | .000       | .000 | .001 | .027           | .000   | .000 | .000       | .001 | .971 |

frequently mixes up GZip, JPEG, PDF, and Microsoft Word files. This misclassification is due partly to the relatively large variance in each fileprint, as Section 4.2.1 describes.

The consumer accuracy confusion matrix in Table 4.8 further confirms that Fileprints performs well regarding the *Code* file types. Of all data the classifier identifies as *Code* only 0.5% is not actually code, but is Microsoft Word or PDF data. Notably, the classifier identifies more PDF data as *GZip* and *JPEG* than *GZip* and *JPEG* data respectively. It also identifies more Word data as *GZip* than *GZip* data, but to a lesser extent. Additionally, it



identifies a relatively large amount of markup and PostScript data as *Text*, a large amount of text data as *PostScript*, and a large amount of PDF data as *GIF*.

Table 4.8: Consumer accuracy confusion matrix for the Fileprints classifier

|        |                | Prediction |      |      |                |        |      |            |      |      |  |
|--------|----------------|------------|------|------|----------------|--------|------|------------|------|------|--|
|        |                | GZip       | JPEG | PDF  | Microsoft Word | Markup | Text | PostScript | GIF  | Code |  |
| Actual | GZip           | .200       | .011 | .001 | .000           | .000   | .000 | .000       | .017 | .000 |  |
|        | JPEG           | .049       | .381 | .006 | .005           | .001   | .003 | .000       | .066 | .000 |  |
|        | PDF            | .461       | .460 | .948 | .006           | .020   | .096 | .032       | .237 | .001 |  |
|        | Microsoft Word | .272       | .139 | .003 | .745           | .098   | .016 | .001       | .169 | .004 |  |
|        | Markup         | .000       | .000 | .000 | .001           | .716   | .212 | .032       | .000 | .000 |  |
|        | Text           | .000       | .000 | .000 | .000           | .112   | .384 | .348       | .000 | .000 |  |
|        | PostScript     | .000       | .000 | .000 | .003           | .046   | .282 | .587       | .000 | .000 |  |
|        | GIF            | .007       | .008 | .001 | .001           | .000   | .000 | .000       | .339 | .000 |  |
|        | ARM            | .003       | .000 | .001 | .005           | .000   | .000 | .000       | .002 | .233 |  |
|        | Motorola 68000 | .000       | .000 | .001 | .033           | .000   | .000 | .000       | .004 | .255 |  |
|        | AVR            | .007       | .001 | .030 | .129           | .007   | .006 | .000       | .164 | .195 |  |
|        | PowerPC        | .000       | .000 | .009 | .073           | .000   | .000 | .000       | .003 | .310 |  |

Table 4.9 provides an overview of Fileprints' performance, and consists of data from the highlighted cells of Tables 4.7 and 4.8. Table 4.9 indicates that the *PDF* file type's large consumer accuracy is due to the classifier identifying very little data as *PDF*. This result is evident because *PDF* producer accuracy is low indicating that it identified few PDFs correctly, yet consumer accuracy is high indicating that 94.8% of all data identified

as *PDF* is actually *PDF*. The *Microsoft Word* file type result is similar, though not to the same extent as *PDF*.

Table 4.9: Fileprints classifier error summary

|                | <b>Producer<br/>Accuracy</b> | <b>Omission<br/>Error</b> | <b>Consumer<br/>Accuracy</b> | <b>Commission<br/>Error</b> |
|----------------|------------------------------|---------------------------|------------------------------|-----------------------------|
| GZip           | 0.942                        | 0.058                     | 0.200                        | 0.800                       |
| JPEG           | 0.763                        | 0.237                     | 0.381                        | 0.619                       |
| PDF            | 0.090                        | 0.910                     | 0.948                        | 0.052                       |
| Microsoft Word | 0.408                        | 0.592                     | 0.745                        | 0.255                       |
| Markup         | 0.808                        | 0.192                     | 0.716                        | 0.284                       |
| Text           | 0.230                        | 0.770                     | 0.384                        | 0.616                       |
| PostScript     | 0.831                        | 0.169                     | 0.587                        | 0.413                       |
| GIF            | 0.875                        | 0.125                     | 0.339                        | 0.661                       |
| ARM            | 0.993                        | 0.007                     | 0.233                        | 0.767                       |
| Motorola 68000 | 0.984                        | 0.016                     | 0.255                        | 0.745                       |
| AVR            | 0.862                        | 0.138                     | 0.195                        | 0.805                       |
| PowerPC        | 0.971                        | 0.029                     | 0.310                        | 0.690                       |

#### 4.3.2 File Statistics

The statistical file classifier Conti et al. describe performs with an overall accuracy of 72.7%, and accuracy among the code file types of 97.4%. The algorithm achieves a 53.6% accuracy with non-code file types. Overall, this system performs slightly better than Fileprints, beating its accuracy by a small margin in all three cases.

Table 4.10 describes producer accuracy results for this algorithm. The classifier performs worst with PDFs, classifying more as *JPEG* than *PDF*. Fileprints' performance

Table 4.10: Producer accuracy confusion matrix for the file statistics classifier

|        |                | Prediction |      |      |                |        |      |            |      |      |
|--------|----------------|------------|------|------|----------------|--------|------|------------|------|------|
|        |                | GZip       | JPEG | PDF  | Microsoft Word | Markup | Text | PostScript | GIF  | Code |
| Actual | GZip           | .569       | .320 | .076 | .005           | .000   | .000 | .001       | .016 | .013 |
|        | JPEG           | .117       | .757 | .004 | .014           | .009   | .003 | .002       | .065 | .029 |
|        | PDF            | .144       | .337 | .304 | .030           | .061   | .042 | .006       | .028 | .049 |
|        | Microsoft Word | .141       | .204 | .017 | .314           | .048   | .082 | .005       | .027 | .161 |
|        | Markup         | .000       | .000 | .000 | .001           | .823   | .156 | .013       | .000 | .008 |
|        | Text           | .000       | .000 | .000 | .000           | .159   | .805 | .025       | .000 | .011 |
|        | PostScript     | .000       | .000 | .081 | .000           | .226   | .272 | .409       | .000 | .011 |
|        | GIF            | .076       | .171 | .008 | .041           | .000   | .000 | .001       | .619 | .084 |
|        | ARM            | .000       | .000 | .000 | .001           | .000   | .000 | .000       | .000 | .999 |
|        | Motorola 68000 | .000       | .004 | .000 | .011           | .003   | .003 | .000       | .001 | .978 |
|        | AVR            | .003       | .004 | .003 | .025           | .006   | .011 | .002       | .003 | .944 |
|        | PowerPC        | .000       | .000 | .000 | .017           | .001   | .005 | .000       | .003 | .974 |

with PDFs is similar, suggesting that PDFs and JPEGs have significant resemblance, at least in byte distribution. The classifier's next-worst performance is with Word documents, classifying 20% as *JPEG*.

Table 4.11 indicates low consumer accuracy for the JPEG files. 46% of data the classifier identifies as *JPEG* is actually PDF, and this result causes the poor *JPEG* consumer accuracy. The classifier's performance on the PDF, Microsoft Word, and JPEG file types also diminished *GIF* consumer accuracy. Table 4.12 provides a summary of the statistical file classifier's performance, and highlights these effects. Notably, with the *Code* file types

Table 4.11: Consumer accuracy confusion matrix for the file statistics classifier

|        |                | Prediction |      |      |                |        |      |            |      |      |
|--------|----------------|------------|------|------|----------------|--------|------|------------|------|------|
|        |                | GZip       | JPEG | PDF  | Microsoft Word | Markup | Text | PostScript | GIF  | Code |
| Actual | GZip           | .269       | .078 | .035 | .003           | .000   | .000 | .000       | .023 | .001 |
|        | JPEG           | .082       | .274 | .003 | .012           | .002   | .001 | .001       | .133 | .002 |
|        | PDF            | .337       | .406 | .701 | .081           | .049   | .032 | .011       | .189 | .011 |
|        | Microsoft Word | .286       | .212 | .033 | .738           | .033   | .054 | .008       | .159 | .032 |
|        | Markup         | .000       | .000 | .001 | .001           | .581   | .104 | .021       | .000 | .002 |
|        | Text           | .000       | .000 | .000 | .000           | .114   | .549 | .042       | .000 | .002 |
|        | PostScript     | .000       | .000 | .218 | .000           | .213   | .243 | .913       | .000 | .003 |
|        | GIF            | .018       | .021 | .002 | .012           | .000   | .000 | .000       | .435 | .002 |
|        | ARM            | .000       | .000 | .000 | .002           | .000   | .000 | .000       | .001 | .218 |
|        | Motorola 68000 | .000       | .004 | .001 | .030           | .002   | .003 | .001       | .010 | .237 |
|        | AVR            | .007       | .004 | .006 | .061           | .004   | .008 | .003       | .021 | .200 |
|        | PowerPC        | .000       | .000 | .000 | .060           | .001   | .005 | .000       | .029 | .290 |

5.5% of data the statistical classifier identifies as *Code* is not. This value is ten times that of Fileprints. This difference in consumer accuracy makes the analyst's job more difficult when using the statistical classifier.

### 4.3.3 Normalized Compression Distance

Table 4.13 presents the NCD classifier producer accuracy. For the 9-class classification problem random guessing produces producer accuracies of 11.1%. In all cases, the NCD classifier performs worse than random guessing. This may reflect problems with the

Table 4.12: File statistics classifier error summary

|                | <b>Producer<br/>Accuracy</b> | <b>Omission<br/>Error</b> | <b>Consumer<br/>Accuracy</b> | <b>Commission<br/>Error</b> |
|----------------|------------------------------|---------------------------|------------------------------|-----------------------------|
| GZip           | 0.569                        | 0.431                     | 0.269                        | 0.731                       |
| JPEG           | 0.757                        | 0.243                     | 0.274                        | 0.726                       |
| PDF            | 0.304                        | 0.696                     | 0.701                        | 0.299                       |
| Microsoft Word | 0.314                        | 0.686                     | 0.738                        | 0.262                       |
| Markup         | 0.823                        | 0.177                     | 0.581                        | 0.419                       |
| Text           | 0.805                        | 0.195                     | 0.549                        | 0.451                       |
| PostScript     | 0.409                        | 0.591                     | 0.913                        | 0.087                       |
| GIF            | 0.619                        | 0.381                     | 0.435                        | 0.565                       |
| ARM            | 0.999                        | 0.001                     | 0.218                        | 0.782                       |
| Motorola 68000 | 0.978                        | 0.022                     | 0.237                        | 0.763                       |
| AVR            | 0.944                        | 0.056                     | 0.200                        | 0.800                       |
| PowerPC        | 0.974                        | 0.026                     | 0.290                        | 0.710                       |

training samples as Section 4.2.3 describes, or the smaller training corpus the research uses for this algorithm.

The classifier assigns the *PostScript* file type to 61% of data, but assigns more than half of all PostScript data to the *Code* file type. Table 4.4 indicates that PostScript samples have a comparatively large ratio of compression length standard deviation to mean, though not as large as Word documents. Thus, compression length varies more for PostScript files than for files of any other type, except Microsoft Word. Additionally, Table 3.1 indicates that PostScript samples make up more of the training corpus, by total data, than any other file

Table 4.13: Producer accuracy confusion matrix for the NCD classifier

|        |                | Prediction |      |      |                |        |      |            |      |      |
|--------|----------------|------------|------|------|----------------|--------|------|------------|------|------|
|        |                | GZip       | JPEG | PDF  | Microsoft Word | Markup | Text | PostScript | GIF  | Code |
| Actual | GZip           | .000       | .000 | .000 | .000           | .000   | .013 | .986       | .000 | .000 |
|        | JPEG           | .000       | .004 | .002 | .000           | .000   | .149 | .842       | .000 | .002 |
|        | PDF            | .000       | .015 | .002 | .029           | .001   | .018 | .864       | .003 | .068 |
|        | Microsoft Word | .000       | .023 | .031 | .016           | .100   | .095 | .561       | .041 | .132 |
|        | Markup         | .000       | .002 | .000 | .166           | .000   | .002 | .031       | .003 | .796 |
|        | Text           | .000       | .024 | .000 | .396           | .000   | .000 | .002       | .211 | .366 |
|        | PostScript     | .000       | .077 | .003 | .273           | .000   | .000 | .000       | .107 | .539 |
|        | GIF            | .000       | .001 | .000 | .001           | .001   | .129 | .867       | .000 | .000 |
|        | ARM            | .000       | .000 | .018 | .000           | .013   | .022 | .947       | .000 | .000 |
|        | Motorola 68000 | .000       | .000 | .000 | .000           | .014   | .032 | .953       | .000 | .000 |
|        | AVR            | .000       | .001 | .005 | .005           | .012   | .047 | .908       | .004 | .019 |
|        | PowerPC        | .000       | .000 | .000 | .000           | .020   | .050 | .929       | .000 | .000 |

type except code. The large proportion of training samples and wide range of compression lengths may make it too difficult for the NCD classifier to succeed.

Table 4.14 provides the consumer accuracy, and shows that the classifier assigns Word documents to every type except *Word*. Table 4.15 provides the error summary results, and shows the classifier is less than 5% accurate, in all cases, on this test set.

The NCD classifier requires 7.6 days to classify the test corpus, while Fileprints and the statistical classifier require 3.5 days each. The NCD classifier can perform only one out of three compressions during the training phase, the other two require the test sample.

Table 4.14: Consumer accuracy confusion matrix for the NCD classifier

|        |                | Prediction |      |      |                |        |      |            |      |      |
|--------|----------------|------------|------|------|----------------|--------|------|------------|------|------|
|        |                | GZip       | JPEG | PDF  | Microsoft Word | Markup | Text | PostScript | GIF  | Code |
| Actual | GZip           | .000       | .000 | .000 | .000           | .000   | .008 | .034       | .000 | .000 |
|        | JPEG           | .000       | .009 | .010 | .000           | .001   | .137 | .043       | .000 | .000 |
|        | PDF            | .000       | .099 | .040 | .034           | .004   | .056 | .148       | .008 | .037 |
|        | Microsoft Word | .893       | .132 | .489 | .016           | .572   | .252 | .083       | .098 | .062 |
|        | Markup         | .078       | .009 | .002 | .167           | .002   | .005 | .005       | .008 | .376 |
|        | Text           | .000       | .142 | .000 | .408           | .001   | .001 | .000       | .527 | .176 |
|        | PostScript     | .000       | .593 | .074 | .369           | .001   | .001 | .000       | .349 | .340 |
|        | GIF            | .000       | .001 | .000 | .000           | .001   | .041 | .015       | .000 | .000 |
|        | ARM            | .002       | .002 | .304 | .000           | .080   | .065 | .153       | .000 | .000 |
|        | Motorola 68000 | .009       | .001 | .001 | .000           | .100   | .102 | .171       | .000 | .000 |
|        | AVR            | .019       | .009 | .077 | .005           | .070   | .132 | .142       | .010 | .009 |
|        | PowerPC        | .000       | .003 | .002 | .000           | .170   | .199 | .205       | .000 | .000 |

During testing NCD performs  $2nm$  compressions, where  $n$  is the number of test samples and  $m$  is the number of training samples.

This research reduces the NCD classifier run time by randomly selecting a subset of the training corpus. A more effective approach uses a clustering algorithm to find samples which best represent a class. Such an algorithm is a research project in itself, and this thesis does not consider the problem.

If this research applied the whole training corpus to the NCD classifier, classification would have required approximately 76 days. In practice, this time requirement is too long,

Table 4.15: NCD classifier error summary

|                | <b>Producer<br/>Accuracy</b> | <b>Omission<br/>Error</b> | <b>Consumer<br/>Accuracy</b> | <b>Commission<br/>Error</b> |
|----------------|------------------------------|---------------------------|------------------------------|-----------------------------|
| GZip           | 0.000                        | 1.000                     | 0.000                        | 1.000                       |
| JPEG           | 0.004                        | 0.996                     | 0.009                        | 0.991                       |
| PDF            | 0.002                        | 0.998                     | 0.040                        | 0.960                       |
| Microsoft Word | 0.016                        | 0.984                     | 0.016                        | 0.984                       |
| Markup         | 0.000                        | 1.000                     | 0.002                        | 0.998                       |
| Text           | 0.000                        | 1.000                     | 0.001                        | 0.999                       |
| PostScript     | 0.000                        | 1.000                     | 0.000                        | 1.000                       |
| GIF            | 0.000                        | 1.000                     | 0.000                        | 1.000                       |
| ARM            | 0.000                        | 1.000                     | 0.000                        | 1.000                       |
| Motorola 68000 | 0.000                        | 1.000                     | 0.000                        | 1.000                       |
| AVR            | 0.019                        | 0.981                     | 0.009                        | 0.991                       |
| PowerPC        | 0.000                        | 1.000                     | 0.000                        | 1.000                       |

and it hinders firmware analysis. The Fileprints and statistical classifiers permit model calculation in advance, so training time does not impact firmware analysis. After training they require comparatively little time to classify a sample.

#### **4.3.4 Code Classifiers**

The decision tree and SVM classifiers perform well overall, with overall accuracies greater than 99%. Their overall errors were  $5.12 \times 10^{-3}$  and  $1.85 \times 10^{-5}$  respectively. Table 4.16 displays the code classifier errors in detail. The code classifier accuracies are so high that error provides a more accurate picture. In several instances the code classifiers are 100% accurate.



Table 4.16: Code classifier omission and commission errors

|                | Omission Error        |                       | Commission Error      |                       |
|----------------|-----------------------|-----------------------|-----------------------|-----------------------|
|                | Decision Tree         | SVM                   | Decision Tree         | SVM                   |
| ARM            | $2.26 \times 10^{-2}$ | $1.12 \times 10^{-7}$ | 0                     | 0                     |
| Motorola 68000 | 0                     | 0                     | $7.41 \times 10^{-5}$ | $7.41 \times 10^{-5}$ |
| AVR            | $8.44 \times 10^{-5}$ | $8.44 \times 10^{-5}$ | 0                     | 0                     |
| PowerPC        | $1.46 \times 10^{-7}$ | $1.46 \times 10^{-7}$ | $1.60 \times 10^{-2}$ | 0                     |

#### 4.4 Whole Pipeline

This section considers the combined accuracy of the binary image segmenter, file type classifier, and code architecture classifier. These form the second, third, and fourth blocks in Figure 3.1. Table 4.17 summarizes the accuracy of the system's entire machine learning pipeline. Data points in the table are the accuracy result of a specific file type classifier and code architecture classifier. This research classified a set of 3,000 pseudo-firmwares with the Fileprints and statistical classifiers, and 1,000 pseudo-firmwares with the NCD classifier. In all cases, the 95% confidence interval has a width smaller than 3.2 percentage points. The combination of Fileprints and SVM, as segment type and code type classifiers respectively, produces the best overall accuracy.

During firmware analysis, however, analysts are likely to value correct identification of code segments higher than correct identification of other segments. The combination of the statistical and SVM classifiers produces the best code identification accuracy. The NCD classifiers perform poorly all around, performing worse than random guessing in all cases, as discussed in Section 4.3.3.

The Fileprints and statistical classifier accuracies conflict, somewhat, with this chapter's earlier results. The test set for Sections 4.3.1 and 4.3.2 consists of whole files,

Table 4.17: Overall accuracy summary, and 95% confidence interval

| File Type | Fileprints  |             | Statistical |             | NCD         |             |
|-----------|-------------|-------------|-------------|-------------|-------------|-------------|
|           | Decision    |             | Decision    |             | Decision    |             |
|           | Tree        | SVM         | Tree        | SVM         | Tree        | SVM         |
| Non-Code  | .577 ± .016 | .577 ± .016 | .323 ± .013 | .323 ± .013 | .004 ± .001 | .004 ± .001 |
| Code      | .817 ± .012 | .827 ± .012 | .846 ± .011 | .858 ± .010 | .039 ± .005 | .040 ± .005 |
| Overall   | .607 ± .014 | .609 ± .014 | .381 ± .013 | .383 ± .013 | .005 ± .001 | .005 ± .001 |

while this section uses a pseudo-firmware test set. Section 3.4 describes the construction of pseudo-firmwares, which approximate true firmwares. The test set difference causes this section's accuracy values to differ from those in earlier sections.

The consumer accuracy of the code segment classifications is also likely to concern analysts. One might focus analysis only on firmware sections classified as code segments, and in that case a higher consumer accuracy gives the analyst less data to sift through. For the Fileprints/SVM combination, the consumer accuracy of the code file types pooled is 86.7%. For the statistical/SVM combination the same consumer accuracy value is 66.2%. The values are significantly different because the statistical classifier incorrectly identifies 4.2% of non-code data as code, while the Fileprints classifier only did so for 0.8%.

This research uses the Fileprints/SVM combination for firmware reverse engineering because of the superior code segment consumer accuracy and overall producer accuracy. The statistical/SVM classifier combination realizes a better code segment producer accuracy, but the difference is small compared to the advantage of Fileprints/acSVM.

Table 4.18 details the system producer accuracies. In all cases, the 95% confidence interval is smaller than 5.4 percentage points. For non-code file types, results are the same regardless of code classifier because the code classifier does not consider segments that the

system identifies as non-code. The non-code file type results are similar to those in earlier sections, but percentages differ because the Table 4.18 results use the pseudo-firmware test set.

Table 4.18: Producer accuracy summary by file type, and 95% confidence interval

| File Type  | Fileprints  |             | Statistical |             | NCD         |             |
|------------|-------------|-------------|-------------|-------------|-------------|-------------|
|            | Decision    |             | Decision    |             | Decision    |             |
|            | Tree        | SVM         | Tree        | SVM         | Tree        | SVM         |
| GZip       | .769 ± .011 | .769 ± .011 | .049 ± .006 | .049 ± .006 | .000 ± .000 | .000 ± .000 |
| JPEG       | .590 ± .022 | .590 ± .022 | .658 ± .017 | .658 ± .017 | .005 ± .003 | .005 ± .003 |
| PDF        | .166 ± .013 | .166 ± .013 | .092 ± .009 | .092 ± .009 | .001 ± .001 | .001 ± .001 |
| Word       | .447 ± .025 | .447 ± .025 | .339 ± .020 | .339 ± .020 | .021 ± .006 | .021 ± .006 |
| Markup     | .612 ± .024 | .612 ± .024 | .480 ± .022 | .480 ± .022 | .016 ± .007 | .016 ± .007 |
| Text       | .234 ± .027 | .234 ± .027 | .660 ± .025 | .660 ± .025 | .006 ± .004 | .006 ± .004 |
| PostScript | .735 ± .022 | .735 ± .022 | .389 ± .020 | .389 ± .020 | .031 ± .008 | .031 ± .008 |
| GIF        | .750 ± .018 | .750 ± .018 | .335 ± .022 | .335 ± .022 | .004 ± .003 | .004 ± .003 |
| ARM        | .762 ± .022 | .828 ± .018 | .809 ± .019 | .884 ± .014 | .030 ± .009 | .035 ± .009 |
| Motorola   | .733 ± .022 | .739 ± .023 | .805 ± .017 | .812 ± .018 | .246 ± .024 | .247 ± .024 |
| AVR        | .659 ± .022 | .639 ± .022 | .730 ± .020 | .710 ± .020 | .057 ± .014 | .047 ± .012 |
| PowerPC    | .821 ± .018 | .805 ± .019 | .827 ± .017 | .813 ± .017 | .035 ± .011 | .035 ± .010 |

The full system results enable detailed analysis of the confusion of each code file type, where the earlier sections pool the code file types. The Fileprints/SVM combination classifies less than 9% of ARM code incorrectly, in the worst case identifying 3% of ARM code as *GIF*. The system classifies 6% of Motorola 68000 code as *Word*, and

3% of PowerPC code as *GIF*. For all three architectures the system has no other type misclassifications greater than 2%.

Of the code file types, the Fileprints/SVM combination shows the worst performance with AVR. It classifies 11% of AVR code as Motorola, and 2% total as ARM or PowerPC. Thus, the system classifies 80% of AVR code as *Code*, though it gets the architecture wrong nearly 1 time out of 6. In practice, this observation suggests that the system would identify the majority of code and apply the correct architecture, giving an analyst a strong hint as to the correct architecture. The system labels 9% of AVR code as GIF, 5% as Word document, and a further 3% as PDF or GZip.

Considering consumer accuracies, 20% of data the system identifies as *Motorola 68000* code is actually *Word* document. As Table 4.6 shows, the average Word document size is four times that of Motorola files, and the random firmware generator includes amounts of data proportional to file size. Consequently, the number of Word document bytes in the pseudo-firmwares is approximately four times that of Motorola 68000 bytes. Some analysis reveals that this proportion of documentation to code is uncharacteristic of real firmwares, and in this case the pseudo-firmwares do not adequately model real firmwares. The 20% value is a consequence of the poor accuracy of Fileprints on Word documents, and the disproportionate amount of Word document bytes to Motorola 68000 bytes.

#### **4.5 Opcode Analysis**

After finding a likely match for a code section's architecture, the system disassembles that section. Disassembly must start at the correct byte offset, and in the firmware image byte offsets are arbitrary. The system does not automatically detect code offsets, instead disassembling code sections at all likely offsets for the identified architecture. For each of the architectures this research considers, the system tries offsets of zero, one, two, and three bytes.

In practice, each disassembly produces a different set of partially-valid code, and the correct disassembly is not obvious. The analyst must manually consider each disassembly and determine which is correct. Appendix A illustrates the difficulty of determining the correct disassembly by providing four disassemblies of a small code section.

Opcode frequency analysis is one method for assisting in the process. The system automates this process by determining the frequency of all opcodes in each disassembly. It then orders the opcodes by frequency, and compares the list to one from other binaries of that architecture. It annotates the ordered list by marking those opcodes that comprise 90% of other binaries. Those opcodes generally appear more frequently in correct disassemblies than in incorrect disassemblies. Appendix A provides a portion of the opcode analysis from a real firmware, and illustrates how an analyst uses that data to determine the correct disassembly.

Table 4.19 presents the results of analyzing 100 Executable and Linkable Format (ELF) binaries from each of this research’s four architectures. Each ELF comes from the test and training corpus described in Section 3.4. Appendix B presents the most frequent 100 opcodes from each architecture, along with frequency values.

Table 4.19: Most frequent opcodes from four architectures

| ARM    |                 | PowerPC |                    |
|--------|-----------------|---------|--------------------|
| Opcode | Description     | Opcode  | Description        |
| ldr    | Load word       | lwz     | Load word and zero |
| mov    | Move            | mr      | Move register      |
| add    | Add             | stw     | Store word         |
| bl     | Branch and link | bl      | Branch and link    |
| str    | Store           | addi    | Add                |
| cmp    | Compare         | li      | Load               |

|       |                      |        |                           |
|-------|----------------------|--------|---------------------------|
| b     | Unconditional branch | b      | Branch                    |
| beq   | Conditional branch   | cmpwi  | Compare                   |
| bx    | Branch and exchange  | beq    | Conditional branch        |
| andeq | Conditional and      | mtctr  | Move                      |
| sub   | Subtract             | bne    | Conditional branch        |
| bne   | Conditional branch   | nop    | No operation              |
| ldrb  | Load                 | mflr   | Move                      |
| push  | Push                 | bctrl  | Unconditional branch      |
| pop   | Pop                  | blr    | Unconditional branch      |
| lsl   | Shift left           | mtlr   | Move                      |
| ldm   | Load multiple        | bctr   | Unconditional branch      |
| strb  | Store byte           | stwu   | Store word                |
| movne | Conditional move     | lis    | Add                       |
| subs  | Subtract             | rlwinm | Rotate word left then And |
|       |                      | add    | Add                       |
|       |                      | cmpw   | Compare                   |
|       |                      | stfd   | Store                     |
|       |                      | addis  | Add                       |

| Motorola 68000 |                      | AVR    |                     |
|----------------|----------------------|--------|---------------------|
| Opcode         | Description          | Opcode | Description         |
| move1          | Move                 | sbc    | Subtract with carry |
| moveal         | Move-aligned         | sbc1   | Subtract with carry |
| bsr1           | Branch to subroutine | rjmp   | Relative jump       |
| addq1          | Add quick            | ori    | Or                  |

|        |                        |       |                    |
|--------|------------------------|-------|--------------------|
| lea    | Load effective address | cpi   | Compare            |
| clr1   | Clear                  | ldd   | Load indirect      |
| pea    | Push effective address | cp    | Compare            |
| tst1   | Test operand           | ldi   | Load               |
| moveq  | Move quick             | sub   | Subtract           |
| beqs   | Conditional branch     | rcall | Call subroutine    |
| unlk   | Unlink                 | subi  | Subtract           |
| cmpl   | Compare                | andi  | And                |
| rts    | Return from subroutine | add   | Add                |
| moveml | Move multiple          | or    | Or                 |
| beqw   | Conditional branch     | mul   | Multiply unsigned  |
| braw   | branch                 | std   | Store indirect     |
| jsr    | Jump to subroutine     | cpc   | Compare with carry |
| bral   | Branch                 | in    | Input from I/O     |
| addl   | Add                    | adc   | Add with carry     |
| jmp    | Jump                   | out   | Output to I/O      |
| bnes   | Conditional branch     | mov   | Move               |
| moveb  | Move                   | nop   | No operation       |
| lsl1   | Left shift             | eor   | Exclusive or       |
| bras   | Branch                 | ld    | Load               |
| linkw  | Link                   | sbis  | Conditional skip   |
| bnew   | Conditional branch     | cbi   | Clear bits         |
| subq1  | Subtract quick         | mulS  | Multiply signed    |
| fmoved | Move                   |       |                    |

Table 4.19 provides a description for the most frequent opcodes that comprise 90% of each architecture's opcodes. These opcodes fall into four categories based on how the compiler generally employs them. Figure 4.13 depicts the proportions each category comprises for each architecture. Notably, for each architecture approximately 25% of instructions are control instructions like branch or jump. For the Motorola 68000 architecture, over 40% of instructions were move-like instructions (move1, moveal, moveq...).

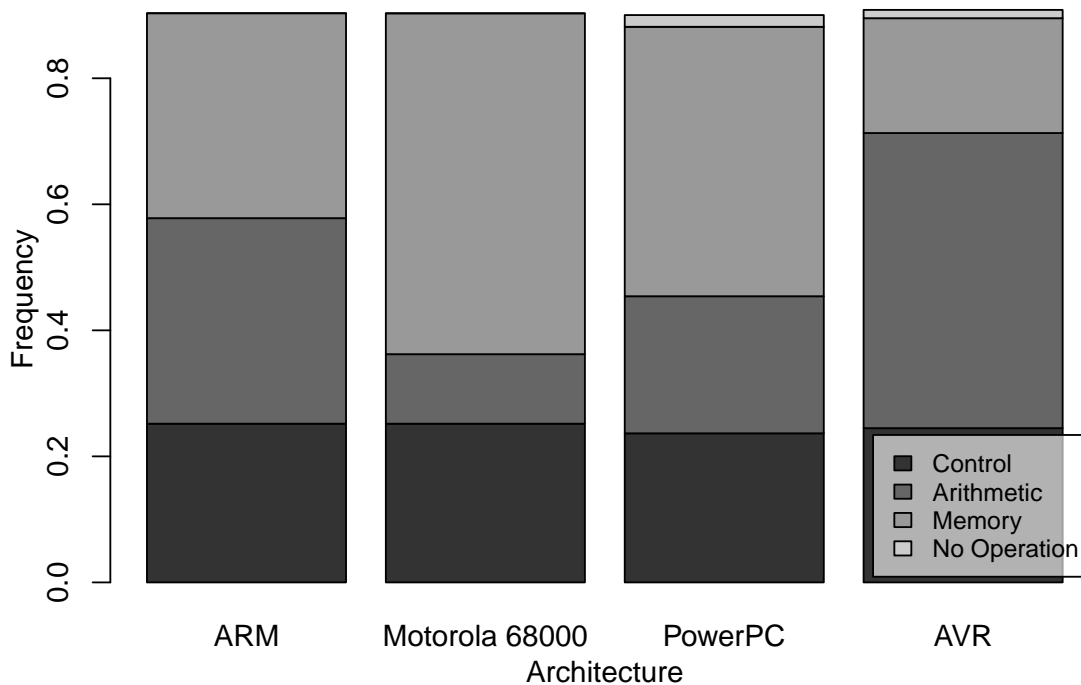

Figure 4.13: Proportions of opcode type

#### 4.6 Firmware Disassembly

While the classifier's performance on test sets is encouraging, the true goal of the system is to disassemble real-world firmwares. This section presents the results of disassembling several Allen-Bradley firmwares. The results from disassembling real



firmwares validate this research's results from pseudo-firmwares. Allen-Bradley includes each within a firmware update tool containing approximately 190 firmware-like binary images. Three categories describe the firmware contents, as Table 4.20 shows. This section details the contents of one firmware from categories one and two, specifically the bold firmwares in Table 4.20.

Table 4.20: Categorization of firmware contents

| Category              | Firmwares  |
|-----------------------|--|
| <i>PPC &amp; ZLib</i> | <b>99449204</b> , 99472767, PN-20032, 99472769,<br>99469405                              |
| <i>ARM &amp; ZLib</i> | <b>PN-20028</b> , PN-19989, 99502404, 99482558<br>PN-20008, PN-50978, PN-20017, PN-50984 |
| <i>ARM Only</i>       | 99502504, PN-19990   |

#### 4.6.1 PPC & ZLib - Firmware 99449204.bin

Firmwares in the *PPC & ZLib* category consist of a binary image with short data and code segments followed by a large, nearly 800 kB, ZLib-compressed segment. The ZLib segment consists of code for PowerPC architecture central processing units (CPUs). With the exception of 99469405.wbn, *PPC & ZLib* firmwares also contain a File Allocation Table (FAT) file system. Firmware 99469405.wbn is 960 kB, while the other *PPC & ZLib* firmwares are between 1.6 MB and 1.8 MB. Peck and Peterson document their disassembly of the *PPC & ZLib* firmware 99472767.wbn [48].

The directory that contains firmware image 99449204.bin contains two other files. One contains only four bytes, and provides no immediate insights into the firmware contents. The other, 99449204.nvs, is a configuration file for the firmware update tool. It contains a line that reveals the destination hardware's identity as 1788-ENBT. The

1788-ENBT is an Ethernet daughtercard for FlexLogix Programmable Logic Controllers (PLCs) providing Internet Protocol (IP) over Ethernet.

With its default settings, Foremost extracts 78 files from the firmware binary. Table 4.21 summarizes Foremost's results. Of the 33 bitmap files Foremost reveals, nine are valid bitmaps and the remainder only contained part of the bitmap header. Foremost extracts 19 valid GIF images. All valid bitmap and GIF images are small icons, likely for use within a webpage. Microsoft Windows executables that Foremost produces are only portions of the binary file that contain the common *MZ* magic number, but are not actually Windows executables.

Foremost extracts 15 HyperText Markup Language (HTML) documents. Each references several GIF images with names matching the contents of the GIF files Foremost produces. These documents form a website displaying status information for the Ethernet interface. The website displays Simple Mail Transfer Protocol (SMTP), Domain Name System (DNS), and basic network configuration properties. It references Javascript files containing a simple client-side Javascript API to retrieve settings dynamically. Foremost output does not include the Javascript files.

Table 4.21: Summary of Foremost output for the firmware

| File Type          | Produced | Valid |
|--------------------|----------|-------|
| Bitmap             | 33       | 9     |
| GIF                | 19       | 19    |
| HTML               | 15       | 15    |
| Windows Executable | 11       | 0     |

Listing the strings within the firmware reveals copyright messages from 2004, error, and status messages, but also the strings "Dhystone Benchmark, Version 2.1"

and “VxWorks 5.5, Mar 31 2005, 11:29:31”. These strings suggest that the firmware incorporates the popular Dhrystone CPU benchmark [75], and that some component of the firmware comes from the VxWorks 5.5 embedded operating system [76].

The *Firmware Disassembly System* identifies and outputs one ZLib-compressed section and 16 non-compressed sections within the firmware. Table 4.22 summarizes the system’s results, and compares them to a manual inspection of the firmware’s results. The system completed firmware analysis in 100 seconds on a consumer-grade laptop with 4 GB random-access memory (RAM) and a dual-core 2.3 GHz CPU. The large PowerPC and Motorola sections, within the system’s results, indicate byte-ranges that merit further analysis.

Bytes 0 through 56904 contain three general sections. The first is a header with ASCII text copyright statements, but otherwise unknown content. The largest section contains binary data which disassembles into plausible assembly code for the PowerPC architecture. Bytes 96774 through 113907 likewise disassemble into plausible PowerPC assembly code when the disassembler uses an offset of two bytes.

The firmware code sections lack any clear metadata, and this makes choosing the correct section disassembly difficult. Disassembly requires correct specification of architecture and code byte offset. Both requirements are difficult to identify because most byte values resolve to an opcode in the four architectures this research considers. Comparing opcode frequency with the training set gives some clue as to whether a particular disassembly is correct. Also, correct code disassembly generally produces a large number of cross-references within the code. These two techniques provide an analyst some insight into a disassembly’s correctness.

The *Firmware Disassembly System* correctly identifies a ZLib-compressed section consisting of bytes 113907 through 889823. It automatically uncompresses this section and performs analysis on it recursively. Uncompressed, the section requires 1.9 MB, but much

Table 4.22: Contents of firmware 99449204.bin

| Firmware Disassembly System |          |          | Manual Inspection |                  |
|-----------------------------|----------|----------|-------------------|------------------|
| Byte Range                  | Size (B) | Assigned | Byte Range        | Actual           |
| 0-55044                     | 55044    | PowerPC  | 0-1400            | File header      |
|                             |          |          | 1400-7960         | Zero Padding     |
|                             |          |          | 7960-56904        | PowerPC          |
| 55044-91740                 | 36696    | Motorola | 56904-96774       | Zero Padding     |
| 91740-110088                | 18348    | Word     | 96774-113907      | PowerPC          |
| 110088-113907               | 3819     | PowerPC  |                   |                  |
| 113907-889823               | 775916   | ZLib     | 113907-889823     | ZLib             |
| 889823-1559580              | 669757   | Motorola | 889823-1572630    | 0xFF Padding     |
| 1559580-1577928             | 18348    | PDF      | 1572630-1834774   | FAT12 Filesystem |
| 1577928-1596276             | 18348    | Word     |                   |                  |
| 1596276-1651320             | 55044    | Markup   |                   |                  |
| 1651320-1669668             | 18348    | Motorola |                   |                  |
| 1669668-1688016             | 18348    | Word     |                   |                  |
| 1688016-1706364             | 18348    | GIF      |                   |                  |
| 1706364-1761408             | 55044    | Motorola |                   |                  |
| 1761408-1779756             | 18348    | Word     |                   |                  |
| 1779756-1798104             | 18348    | Motorola |                   |                  |
| 1798104-1816452             | 18348    | Word     |                   |                  |
| 1816452-1834774             | 18322    | PDF      |                   |                  |

of it consists of padding bytes 0xFF and 0x00. The entire compressed section contains PowerPC code and associated data sections.

Analysis reveals a common 16 B symbol table pattern, starting at byte offset 0x001CF91C. Figure 4.14 shows a portion of the symbol table. Four bytes identify the address of a string containing a function name, then four bytes identify the address of the corresponding function. Byte eleven contains either 0x05, 0x07 or 0x09, and only lines containing 0x05 correspond with a function definition. The other seven bytes are always 0x00. The addresses in the symbol table assume a code offset of 0x00100000, thus this value is the correct loading offset for the PowerPC code. Figure 4.14 depicts the symbol table at the correct loading offset, where it starts at byte offset 0x002CF91C.

```

002D060C  00 2C 1F 0C 00 12 93 48 00 00 05 00 00 00 00 00
002D061C  00 2C 1E FC 00 19 CF EC 00 00 05 00 00 00 00 00
002D062C  00 2C 1E E8 00 12 93 D8 00 00 05 00 00 00 00 00
002D063C  00 2C 1E CC 00 12 A7 0C 00 00 05 00 00 00 00 00
002D064C  00 2C 1E C0 00 12 94 28 00 00 05 00 00 00 00 00
002D065C  00 2C 1E B8 00 12 81 0C 00 00 05 00 00 00 00 00
002D066C  00 2C 1E AC 00 10 C5 A4 00 00 05 00 00 00 00 00
002D067C  00 2C 1E 98 00 19 D0 AC 00 00 05 00 00 00 00 00

```

Figure 4.14: Symbol table contained in firmware 99449204.bin

The symbol table provides names for the majority of functions IDA Pro identifies. The resulting disassembly, with correct code offset, has a dense function call graph. Figure 4.15 shows several named function calls within the function `UsrInit`. Function names ease code analysis, and in this case suggest that the function performs some part of the system initialization. The *Firmware Disassembly System* does not identify the symbol table as such, but does identify it as a section separate from the PowerPC code. This automatic analysis simplifies firmware analysis overall.

Near the symbol table, the PowerPC code data section contains two small GZip sections. The first uncompresses to a 216 B, 32x32 pixel Windows icon resembling the

```

ROM:001029D4 bl cacheLibInit
ROM:001029D8 bl excVecInit
ROM:001029DC bl sysHwInit
ROM:001029E0 li %r3, 0
ROM:001029E4 bl cacheEnable
ROM:001029E8 li %r3, 1
ROM:001029EC bl cacheEnable
ROM:001029F0 bl classLibInit
ROM:001029F4 bl taskLibInit
ROM:001029F8 lis %r9, ((qPriBMapClassId+0x10000)@h)
ROM:001029FC lwz %r4, qPriBMapClassId@l(%r9)
ROM:00102A00 lis %r3, 0x30 # 0x300E3C
ROM:00102A04 lis %r5, 0x30 # 0x301BBC
ROM:00102A08 addi %r5, %r5, 0x1BBC # 0x301BBC
ROM:00102A0C li %r6, 0x100
ROM:00102A10 addi %r3, %r3, 0xE3C # 0x300E3C
ROM:00102A14 bl qInit
ROM:00102A18 lis %r9, ((qFifoClassId+0x10000)@h)

```

Figure 4.15: Code from the function `UsrInit`

1788-ENBT Ethernet card. The second is an Allen-Bradley electronic data sheet (EDS) network configuration file, providing basic information about the Ethernet card.

#### 4.6.2 ARM & ZLib - Firmware `PN-20028.bin`

*ARM & ZLib* firmwares begin with an ARM code segment, then contain between two and fourteen compressed files, then end with multiple short data segments separated by `0x00` or `0xFF` padding bytes. Each firmware is between 1.4 MB and 1.9 MB in size, and the ARM segment comprises between 1.2 and 1.8 MB.

At least two configuration files, with the `.nvs` file extension, refer to firmware `PN-20028.bin`. They indicate that it targets both the 1769-L32E and 1769-L32C devices. Both devices are communications modules for CompactLogix PLCs [54]. The `.nvs` files indicate that firmwares `PN-20032.bin` and `PN-20030.bin` target devices 1769-L32E and 1769-L32C respectively. Firmware `PN-20032` is a *PPC & ZLib* firmware, and this research does not investigate firmware `PN-20030`.

Foremost produces one JPEG and one bitmap (BMP) file. The JPEG file contains the magic number `0xFFD8FF`, while the BMP file contains the magic number `BM`. Neither file is a valid image, they contain sections of binary data that include JPEG and BMP magic

numbers. Listing the strings within the firmware produces device names, error messages, source file names, and the compiler name. The device names are consistent with this section's analysis. Strings reveal that the code is C or C++, and the compiler toolkit is the ARM Developer Suite version 1.2, released in November 2001 [6].

Table 4.23 describes the *Firmware Disassembly System* output and the results of manual firmware inspection. The firmware's strings suggest that it contains code for ARM architecture processors, and the *Firmware Disassembly System* output indicates that ARM code comprises the majority of the firmware. The ARM code sections merit further analyst attention. Additionally, the system suggests that a zero byte offset results in correct code disassembly.

Table 4.23: Contents of firmware PN-20028.bin

| Firmware Disassembly System |          |               | Manual Inspection |                                       |
|-----------------------------|----------|---------------|-------------------|---------------------------------------|
| Byte Range                  | Size (B) | Assigned      | Byte Range        | Actual                                |
| 0-1538024                   | 1538024  | ARM           | 0-1744908         | ARM                                   |
| 1538024-1541673             | 3649     | Word          |                   |                                       |
| 1541673-1555908             | 14235    | PowerPC       |                   |                                       |
| 1555908-1573792             | 17884    | GIF           |                   |                                       |
| 1573792-1627444             | 53652    | Motorola      |                   |                                       |
| 1627444-1663212             | 35768    | ARM           |                   |                                       |
| 1663212-1744908             | 81696    | Word          |                   |                                       |
| 1744908-1756829             | 11921    | 16 ZLib Files | 1744908-1756829   | 16 ZLib Files                         |
| 1756829-1781248             | 24419    | Word          | 1756829-1788344   | Sparse binary data,<br>unknown format |
| 1781248-1785924             | 4676     | Motorola      |                   |                                       |
| 1785924-1788344             | 2420     | ARM           |                   |                                       |

Manual analysis does not reveal a symbol table, and therefore does not resolve the code's function names or the code's loading address. Fortunately, this firmware's function calls use relative addressing, and IDA Pro automatically determines the location of many of the firmware's functions. After automatic analysis IDA Pro leaves few byte ranges unexplored. Figure 4.16 shows a portion of the code diagram IDA Pro generated. The majority of unexplored sections contain data or padding, but manual analysis reveals some code within those sections.

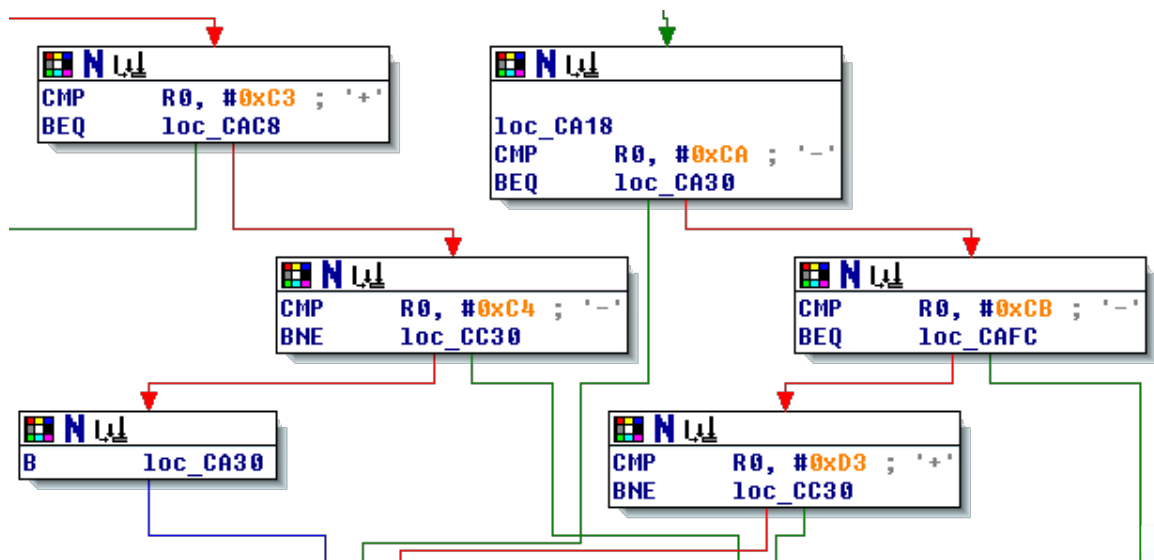

Figure 4.16: A portion of the IDA Pro code diagram for PN-20028.bin

Firmware PN-20028.bin contains fourteen compressed sections, and the *Firmware Disassembly System* correctly identifies each. Seven compressed sections are EDS files, and seven are Windows icons resembling PLC components. EDS files contain ASCII text that describes the configuration properties of a device [55]. They assist operators during network configuration.



### 4.6.3 ARM Only

The *ARM Only* firmwares are similar to the *ARM & ZLib* firmwares, but only contain an ARM code section. Additionally, *ARM Only* firmwares are smaller. Both are approximately 170 kB. IDA Pro's automatic analysis identifies many function entry points, as it did for *ARM & ZLib* firmwares.

### 4.6.4 Strengths and Weaknesses

This exercise reveals some strengths and weaknesses of the current iteration of the *Firmware Disassembly System*. The system significantly reduces the time required for firmware analysis by automatically identifying relevant sections. It automatically identifies the architecture of code sections and disassembles them. The system automatically finds compressed sections within the firmware and recursively analyzes them.

Unfortunately, the *Firmware Disassembly System* performs poorly when it encounters sections filled with padding. Padding bytes `0x00` and `0xFF` cause the system to identify sections as Motorola 68000 code. Figures 4.17 and 4.18 summarize the system's performance on firmwares `99449204.bin` and `PN-20028.bin`, respectively. The system misidentifies each *padding* byte range, in Figure 4.17, as Motorola 68000. This misclassification only slightly hinders analysis efforts, as the system's error is evident upon brief inspection. Figure 4.18 contains no padding byte ranges because firmware `PN-20028.bin` only contains small padding segments. The file segmenter includes those small padding segments within larger segments, which the system then misclassifies as *Word* as Table 4.23 shows. Future iterations of the *Firmware Disassembly System* may address the padding section misclassification by finding large sections of padding bytes and removing them prior to further analysis.

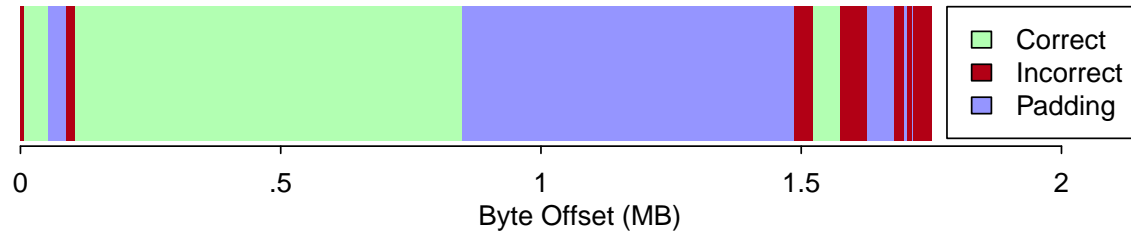

Figure 4.17: Summary of system performance on firmware 99449204.bin



Figure 4.18: Summary of system performance on firmware PN-20028.bin

## 5 Conclusions

This research described the algorithms comprising the *Firmware Disassembly System*, a tool to assist analysts with PLC firmware disassembly. The system found compressed sections, determined the file type of byte ranges within the firmware, automatically disassembled likely code sections, and provided opcode frequency analysis for human reference. The process required machine learning algorithms, and the majority of this research involved selecting those algorithms.

The machine learning algorithms that identified firmware segment file types required firmware segments upon which to operate. Section 4.1 analyzed the performance of four file segmenting algorithms. Two were variations on a sliding window, and two used a measure of instantaneous file entropy. The sliding window algorithms outperformed the entropy algorithms, both in speed and accuracy. Consequently, the *Firmware Disassembly System* segmented files with a sliding window. Specifically, it divided files into 100 segments, or 512 B segments, whichever are larger.

Identifying the file type of byte ranges is similar to a technique called *file carving*, so this research applied three file carving algorithms to the problem. One algorithm considered four statistical features of each sample, while another used normalized compression distance. This research revealed that the most successful file carving algorithm for this problem was Fileprints. Fileprints models file types as the mean and variance of byte-value frequency in the training set. On a 10,845 file test corpus consisting of 9 classes of file type, Fileprints achieved a 71.3% accuracy overall, and a 95.6% accuracy when identifying executable code segments.

After the file type classifier identifies the file type of each segment, another machine learning algorithm must identify the architecture and endianness of the code segments. This research applied two malware identification algorithms to the code classification problem.

Both algorithms applied information gain to byte-value 4-grams to identify classification attributes. One used a decision tree classifier, and the other used an SVM classifier. The SVM classifier produced the best results, achieving better than 99% accuracy.

The *Firmware Disassembly System* employed the Fileprints and SVM classifiers. This research applied the system to a set of pseudo-firmwares. The system achieved 57.7% accuracy with non-code segments, 82.7% accuracy with code segments, and 60.9% accuracy overall. The relatively high code segment accuracy indicates that the system provides analysts with accurate information regarding code location and architecture.

After evaluating the machine learning classifiers, Section 4.5 identified opcode frequency for the four most-common PLC processor architectures. These results assist firmware disassembly by giving the analyst an indicator if a particular disassembly is valid. The research identified the opcodes that comprise 90% of code for each architecture, or approximately 20 opcodes for each. The *Firmware Disassembly System* employed these results to automate some disassembly analysis.

Finally, this research analyzed several Allen-Bradley PLC firmwares to validate the experimental methodology. Three categories described the firmwares. Firmwares in the first category contained a large ZLib-compressed section, and all but one contained a FAT12 filesystem. The compressed section contained PowerPC code. Firmwares in the second and third categories contained ARM processor code, and second category firmwares contained several compressed configuration and icon file sections.

## 5.1 Limitations

The *Firmware Disassembly System* performs poorly on padding-byte sections, classifying them as Motorola 68000 code. Every validation firmware contains padding sections, and incorrect classification makes firmware analysis more difficult. A future iteration of the system should screen out padding sections before further analysis. Additionally, while the system's 85.3% accuracy on code sections is reasonable, future

iterations of the system must improve the 60.1% overall performance. Finally, the system only incorporates three common firmware compression algorithms. Some firmwares likely include data using other compression schemes, although this research found none.

## 5.2 Future Work

Several possibilities exist for future work with this system. One major hurdle that remains during firmware analysis is identifying a code segment's loading address. The loading address is critical to reverse engineering when code contains jumps or branches using absolute addressing. In that case, an analyst cannot build a function call graph without the loading address. The loading address also enables analysts to resolve code references to data. This research leveraged information in a symbol table, and found a symbol table format common to at least two Allen-Bradley PowerPC PLC firmwares. Future research might determine how common that symbol table format is, and might identify common symbol table formats for other architectures. Manufacturers may strip symbol tables out of firmwares before distribution, so future research should consider other techniques for determining loading address. One such technique considers switch conditional jump tables. Future research might investigate this method further, identifying common jump table formats for different architectures.

This research only applied five machine learning algorithms to the reverse engineering problem. The NCD classifier performed poorly, and future research might investigate ways to improve its performance to better match Axelsson's results [7]. This research found that the code classification algorithms performed well, and future research might apply the decision tree and SVM algorithms to the file type identification problem. Future research might consider simplifying the system block structure by combining the file type and code architecture classification steps. Unfortunately, the information gain attribute selection technique incurs a time/memory tradeoff that made application to the 9-class file type problem infeasible for this research. Future research might consider eliminating some of

the file types, or might combine multiple types into logical groups. Each of these research avenues has the potential to improve the system's overall classification accuracy.

The *Firmware Disassembly System*'s analysis ends with code disassembly. Future research might expand the system, applying existing static code analysis techniques to automate vulnerability discovery. Future research might examine techniques to compare pristine firmware to forensically-recovered firmware. Both techniques would significantly aid analysis of rogue firmwares, the true use case of this system. Many obstacles exist to PLC firmware dynamic code analysis, and hardware emulation in particular, and it is also fertile ground for future research.

The *Firmware Disassembly System* process applies to firmwares in general, and not just PLC firmwares. Future research might apply a similar system to printer firmwares, or commercial off-the-shelf (COTS) networking hardware firmwares. The security of both device classes is relatively unexplored, yet devices from both classes are present on many networks. Insecure printer and networking hardware firmware might act as a network back door, or a launching point for other network attacks.

Finally, future work should automate the process of finding malicious and buggy code within firmwares. This research designed the *Firmware Disassembly System* as a preprocessor for that future system. The larger system might apply existing code analysis tools to the code sections that the *Firmware Disassembly System* reveals. Automated malware and bug detection tools would enable a *firmware clearing house* capable of validating firmware security prior to installation, and would speed reaction by a critical infrastructure (CI) computer emergency response team (CERT). Such a system would eventually reduce CI vulnerabilities, and improve CI reliability.

Recent increases in CI system network connectivity, and advances in attacker knowledge of firmware, necessitate faster firmware reverse engineering techniques. This thesis applied machine learning algorithms to the firmware reverse engineering problem,

then developed a reverse engineering process, and implemented that process in the *Firmware Disassembly System*. Critically, the *Firmware Disassembly System*'s automatic disassembly and analysis permitted quick identification of PLC firmware target architecture without possessing the PLC. The system automatically identified sections that merit further analysis, while limiting the amount of distracting extraneous output. The *Firmware Disassembly System* automatically uncompressed all firmware components and produced the assembly-language code comprising a firmware. It completed this tedious process considerably faster than other techniques. The combination of these qualities make the *Firmware Disassembly System* unique.

## Appendix A: Disassembly at Four Offsets

For the four architectures this research considers, bytes representing code have at least four potential disassemblies. These correspond to initial byte offsets of zero, one, two, or three bytes. This appendix illustrates the difficulty inherent in choosing the correct disassembly. It provides four disassemblies of the same code section from firmware PN-20032, one disassembly for each offset. Firmware PN-20032 contains PowerPC code. Each disassembly for this code section contains bytes that do not resolve as valid opcodes, and each contains bytes that do resolve as valid opcodes. This fact makes it difficult for an analyst to immediately determine the correct disassembly. The correct disassembly results from a three byte offset.

This appendix also provides the first twenty entries in the *Firmware Disassembly System's* opcode analysis results for each disassembly. A preponderance of popular opcodes within a disassembly provides an analyst with a quick indicator of that disassembly's correctness. An opcode is *popular* when it is part of the group of opcodes that comprise 90% of an architecture's code. Table 4.19 gives the *popular* opcodes for each architecture. The most frequent opcodes in offset three's analysis are all popular, and this is not the case for the other disassemblies. This correctly suggests that the correct disassembly results from a three byte offset.



Table A.1: Offset zero disassembly

| Address | Byte Values | Disassembly Result    |
|---------|-------------|-----------------------|
| 2c9c8:  | a0 be 5c 00 | lhz r5,23552(r30)     |
| 2c9cc:  | 00 03 fd 83 | .long 0x3fd83         |
| 2c9d0:  | 2b f4 a6 d9 | cmpli cr7,1,r20,42713 |
| 2c9d4:  | 86 7e 2a 00 | lwzu r19,10752(r30)   |
| 2c9d8:  | 00 03 fe 89 | .long 0x3fe89         |
| 2c9dc:  | 2a ec df de | cmpli cr5,1,r12,57310 |
| 2c9e0:  | 95 47 b5 00 | stwu r10,-19200(r7)   |
| 2c9e4:  | 00 03 fe 8f | .long 0x3fe8f         |
| 2c9e8:  | 00 5d 5e f7 | .long 0x5d5ef7        |
| 2c9ec:  | f5 9f 9b 00 | .long 0xf59f9b00      |
| 2c9f0:  | 00 03 fe 94 | .long 0x3fe94         |
| 2c9f4:  | ac 72 c9 84 | lhau r3,-13948(r18)   |
| 2c9f8:  | 71 86 f6 00 | andi. r6,r12,62976    |
| 2c9fc:  | 00 03 fe 9a | .long 0x3fe9a         |
| 2ca00:  | 2f 80 e6 71 | cmpwi cr7,r0,-6543    |
| 2ca04:  | bd da 20 00 | stmw r14,8192(r26)    |
| 2ca08:  | 00 03 fe 9f | .long 0x3fe9f         |
| 2ca0c:  | 89 fd c4 f4 | lbz r15,-15116(r29)   |
| 2ca10:  | b7 a1 ed 00 | sthu r29,-4864(r1)    |
| 2ca14:  | 00 03 fe a4 | .long 0x3fea4         |
| 2ca18:  | bc 7d 19 34 | stmw r3,6452(r29)     |

Table A.2: Offset one disassembly

| Address | Byte Values | Disassembly Result       |
|---------|-------------|--------------------------|
| 2c9c8:  | be 5c 00 00 | stmw r18,0(r28)          |
| 2c9cc:  | 03 fd 83 2b | .long 0x3fd832b          |
| 2c9d0:  | f4 a6 d9 86 | .long 0xf4a6d986         |
| 2c9d4:  | 7e 2a 00 00 | cmp cr4,1,r10,r0         |
| 2c9d8:  | 03 fe 89 2a | .long 0x3fe892a          |
| 2c9dc:  | ec df de 95 | .long 0xecdfde95         |
| 2c9e0:  | 47 b5 00 00 | .long 0x47b50000         |
| 2c9e4:  | 03 fe 8f 00 | .long 0x3fe8f00          |
| 2c9e8:  | 5d 5e f7 f5 | rlwnm. r30,r10,r30,31,26 |
| 2c9ec:  | 9f 9b 00 00 | stbu r28,0(r27)          |
| 2c9f0:  | 03 fe 94 ac | .long 0x3fe94ac          |
| 2c9f4:  | 72 c9 84 71 | andi. r9,r22,33905       |
| 2c9f8:  | 86 f6 00 00 | lwzu r23,0(r22)          |
| 2c9fc:  | 03 fe 9a 2f | .long 0x3fe9a2f          |
| 2ca00:  | 80 e6 71 bd | lwz r7,29117(r6)         |
| 2ca04:  | da 20 00 00 | stfd f17,0(0)            |
| 2ca08:  | 03 fe 9f 89 | .long 0x3fe9f89          |
| 2ca0c:  | fd c4 f4 b7 | .long 0xfdc4f4b7         |
| 2ca10:  | a1 ed 00 00 | lhz r15,0(r13)           |
| 2ca14:  | 03 fe a4 bc | .long 0x3fea4bc          |
| 2ca18:  | 7d 19 34 f7 | .long 0x7d1934f7         |

Table A.3: Offset two disassembly

| Address | Byte Values | Disassembly Result       |
|---------|-------------|--------------------------|
| 2c9c8:  | 5c 00 00 03 | rlwnm. r0,r0,r0,0,1      |
| 2c9cc:  | fd 83 2b f4 | .long 0xfd832bf4         |
| 2c9d0:  | a6 d9 86 7e | lhzu r22,-31106(r25)     |
| 2c9d4:  | 2a 00 00 03 | cmplwi cr4,r0,3          |
| 2c9d8:  | fe 89 2a ec | .long 0xfe892aec         |
| 2c9dc:  | df de 95 47 | stfdu f30,-27321(r30)    |
| 2c9e0:  | b5 00 00 03 | sthu r8,3(0)             |
| 2c9e4:  | fe 8f 00 5d | .long 0xfe8f005d         |
| 2c9e8:  | 5e f7 f5 9f | rlwnm. r23,r23,r30,22,15 |
| 2c9ec:  | 9b 00 00 03 | stb r24,3(0)             |
| 2c9f0:  | fe 94 ac 72 | .long 0xfe94ac72         |
| 2c9f4:  | c9 84 71 86 | lfd f12,29062(r4)        |
| 2c9f8:  | f6 00 00 03 | .long 0xf6000003         |
| 2c9fc:  | fe 9a 2f 80 | .long 0xfe9a2f80         |
| 2ca00:  | e6 71 bd da | .long 0xe671bdda         |
| 2ca04:  | 20 00 00 03 | subfic r0,r0,3           |
| 2ca08:  | fe 9f 89 fd | fnmsub. f20,f31,f7,f17   |
| 2ca0c:  | c4 f4 b7 a1 | lfsu f7,-18527(r20)      |
| 2ca10:  | ed 00 00 03 | .long 0xed000003         |
| 2ca14:  | fe a4 bc 7d | fnmsub. f21,f4,f17,f23   |
| 2ca18:  | 19 34 f7 09 | .long 0x1934f709         |

Table A.4: Offset three disassembly

| Address | Byte Values | Disassembly Result   |
|---------|-------------|----------------------|
| 2c9c8:  | 00 00 03 fd | .long 0x3fd          |
| 2c9cc:  | 83 2b f4 a6 | lwz r25,-2906(r11)   |
| 2c9d0:  | d9 86 7e 2a | stfd f12,32298(r6)   |
| 2c9d4:  | 00 00 03 fe | .long 0x3fe          |
| 2c9d8:  | 89 2a ec df | lbz r9,-4897(r10)    |
| 2c9dc:  | de 95 47 b5 | stfdu f20,18357(r21) |
| 2c9e0:  | 00 00 03 fe | .long 0x3fe          |
| 2c9e4:  | 8f 00 5d 5e | lbzu r24,23902(0)    |
| 2c9e8:  | f7 f5 9f 9b | .long 0xf7f59f9b     |
| 2c9ec:  | 00 00 03 fe | .long 0x3fe          |
| 2c9f0:  | 94 ac 72 c9 | stwu r5,29385(r12)   |
| 2c9f4:  | 84 71 86 f6 | lwzu r3,-30986(r17)  |
| 2c9f8:  | 00 00 03 fe | .long 0x3fe          |
| 2c9fc:  | 9a 2f 80 e6 | stb r17,-32538(r15)  |
| 2ca00:  | 71 bd da 20 | andi. r29,r13,55840  |
| 2ca04:  | 00 00 03 fe | .long 0x3fe          |
| 2ca08:  | 9f 89 fd c4 | stbu r28,-572(r9)    |
| 2ca0c:  | f4 b7 a1 ed | .long 0xf4b7a1ed     |
| 2ca10:  | 00 00 03 fe | .long 0x3fe          |
| 2ca14:  | a4 bc 7d 19 | lhzu r5,32025(r28)   |
| 2ca18:  | 34 f7 09 24 | addic. r7,r23,2340   |

Table A.5: Offset zero opcode analysis

| <b>Opcode</b> | <b>Opcode Is<br/><i>Popular</i></b> | <b>Frequency in<br/>disassembly</b> |
|---------------|-------------------------------------|-------------------------------------|
| lwz           | True                                | 0.2386                              |
| ori           | False                               | 0.1144                              |
| subfic        | False                               | 0.1033                              |
| mulli         | False                               | 0.0828                              |
| lhz           | False                               | 0.0579                              |
| lfs           | False                               | 0.0530                              |
| xori          | False                               | 0.0429                              |
| cmplwi        | False                               | 0.0305                              |
| lis           | True                                | 0.0299                              |
| stbu          | False                               | 0.0231                              |
| lwzu          | False                               | 0.0190                              |
| stmw          | False                               | 0.0179                              |
| bl            | True                                | 0.0145                              |
| stfdu         | False                               | 0.0121                              |
| lhzu          | False                               | 0.0118                              |
| lfsu          | False                               | 0.0100                              |
| lbz           | False                               | 0.0088                              |
| oris          | False                               | 0.0086                              |
| b             | True                                | 0.0080                              |
| cmpli         | False                               | 0.0079                              |

Table A.6: Offset one opcode analysis

| <b>Opcode</b> | <b>Opcode Is<br/><i>Popular</i></b> | <b>Frequency in<br/>disassembly</b> |
|---------------|-------------------------------------|-------------------------------------|
| rlmi          | False                               | 0.0644                              |
| subfic        | False                               | 0.0580                              |
| addic         | False                               | 0.0533                              |
| addis         | True                                | 0.0473                              |
| rlwimi        | False                               | 0.0424                              |
| stfd          | True                                | 0.0409                              |
| lwz           | True                                | 0.0402                              |
| cmpli         | False                               | 0.0295                              |
| addi          | True                                | 0.0267                              |
| lfs           | False                               | 0.0243                              |
| stfs          | False                               | 0.0242                              |
| b             | True                                | 0.0236                              |
| lwzu          | False                               | 0.0218                              |
| stfsu         | False                               | 0.0211                              |
| ori           | False                               | 0.0200                              |
| bl            | True                                | 0.0186                              |
| twi           | False                               | 0.0182                              |
| lbzu          | False                               | 0.0175                              |
| lfd           | False                               | 0.0175                              |
| ba            | False                               | 0.0169                              |

Table A.7: Offset two opcode analysis

| <b>Opcode</b> | <b>Opcode Is<br/><i>Popular</i></b> | <b>Frequency in<br/>disassembly</b> |
|---------------|-------------------------------------|-------------------------------------|
| subfic        | False                               | 0.0857                              |
| addic         | False                               | 0.0707                              |
| lhzu          | False                               | 0.0619                              |
| mulli         | False                               | 0.0520                              |
| cmpwi         | True                                | 0.0514                              |
| dozi          | False                               | 0.0458                              |
| addi          | True                                | 0.0310                              |
| cmpli         | False                               | 0.0307                              |
| cmpi          | False                               | 0.0307                              |
| addis         | True                                | 0.0275                              |
| rlwimi        | False                               | 0.0275                              |
| vaddubm       | False                               | 0.0243                              |
| twlgti        | False                               | 0.0206                              |
| cmplwi        | False                               | 0.0202                              |
| tweqi         | False                               | 0.0189                              |
| twi           | False                               | 0.0145                              |
| stfs          | False                               | 0.0137                              |
| ori           | False                               | 0.0132                              |
| lwz           | True                                | 0.0124                              |
| rlwinm        | True                                | 0.0123                              |

Table A.8: Offset three opcode analysis

| <b>Opcode</b> | <b>Opcode Is<br/><i>Popular</i></b> | <b>Frequency in<br/>disassembly</b> |
|---------------|-------------------------------------|-------------------------------------|
| lwz           | True                                | 0.1477                              |
| stw           | True                                | 0.0915                              |
| mr            | True                                | 0.0838                              |
| li            | True                                | 0.0768                              |
| addi          | True                                | 0.0680                              |
| bl            | True                                | 0.0613                              |
| lis           | True                                | 0.0546                              |
| cmpwi         | True                                | 0.0494                              |
| beq           | True                                | 0.0464                              |
| b             | True                                | 0.0344                              |
| bne           | True                                | 0.0276                              |
| rlwinm        | True                                | 0.0197                              |
| lbz           | False                               | 0.0165                              |
| mtlr          | True                                | 0.0161                              |
| ori           | False                               | 0.0139                              |
| blr           | True                                | 0.0136                              |
| lhz           | False                               | 0.0124                              |
| add           | True                                | 0.0110                              |
| cmpw          | True                                | 0.0105                              |
| or            | False                               | 0.0101                              |



## Appendix B: Opcode Frequency Analysis

This appendix lists the results of the opcode frequency analysis for 100 ELF binaries from each of four architectures. Opcode frequency for a particular file is given by Equation B.1. In each table, mean frequency and variance measure the mean and variance of the opcode frequencies for individual files. Pooled frequency is from all binaries considered as one file.

$$\text{opcode frequency} = \frac{\text{number of occurrences of an opcode within a file}}{\text{total opcodes in the file}} \quad (\text{B.1})$$

### B.1 ARM Opcodes

Table B.1: Top 100 opcodes for ARM

| Mnemonics | Pooled Frequency | Mean Frequency | Variance               |
|-----------|------------------|----------------|------------------------|
| ldr       | 0.204            | 0.204          | 0.012                  |
| mov       | 0.176            | 0.151          | $5.460 \times 10^{-3}$ |
| add       | 0.096            | 0.075          | $2.796 \times 10^{-3}$ |
| bl        | 0.087            | 0.062          | $2.962 \times 10^{-3}$ |
| str       | 0.072            | 0.068          | $1.613 \times 10^{-3}$ |
| cmp       | 0.061            | 0.054          | $8.199 \times 10^{-4}$ |
| b         | 0.032            | 0.027          | $2.924 \times 10^{-4}$ |
| beq       | 0.030            | 0.031          | $4.513 \times 10^{-4}$ |
| bx        | 0.024            | 0.031          | $8.370 \times 10^{-4}$ |
| andeq     | 0.024            | 0.017          | $4.724 \times 10^{-4}$ |
| sub       | 0.020            | 0.016          | $4.595 \times 10^{-4}$ |
| bne       | 0.019            | 0.014          | $1.069 \times 10^{-4}$ |

|        |                        |                        |                        |
|--------|------------------------|------------------------|------------------------|
| ldrb   | 0.012                  | 0.015                  | $3.959 \times 10^{-4}$ |
| push   | 0.011                  | 0.011                  | $6.938 \times 10^{-5}$ |
| pop    | 0.011                  | 0.010                  | $5.694 \times 10^{-5}$ |
| lsl    | $6.797 \times 10^{-3}$ | $4.503 \times 10^{-3}$ | $5.574 \times 10^{-5}$ |
| ldm    | $6.160 \times 10^{-3}$ | $3.808 \times 10^{-3}$ | $9.832 \times 10^{-5}$ |
| strb   | $4.328 \times 10^{-3}$ | $2.939 \times 10^{-3}$ | $2.253 \times 10^{-5}$ |
| movne  | $4.201 \times 10^{-3}$ | $2.998 \times 10^{-3}$ | $9.699 \times 10^{-6}$ |
| subs   | $4.128 \times 10^{-3}$ | $2.883 \times 10^{-3}$ | $1.383 \times 10^{-5}$ |
| mvn    | $3.726 \times 10^{-3}$ | $2.678 \times 10^{-3}$ | $1.481 \times 10^{-5}$ |
| rsb    | $3.715 \times 10^{-3}$ | $2.462 \times 10^{-3}$ | $1.347 \times 10^{-5}$ |
| orr    | $3.701 \times 10^{-3}$ | $2.818 \times 10^{-3}$ | $8.505 \times 10^{-5}$ |
| moveq  | $3.688 \times 10^{-3}$ | $2.694 \times 10^{-3}$ | $1.259 \times 10^{-5}$ |
| and    | $3.510 \times 10^{-3}$ | $2.664 \times 10^{-3}$ | $3.248 \times 10^{-5}$ |
| ldreq  | $2.564 \times 10^{-3}$ | $2.435 \times 10^{-3}$ | $1.240 \times 10^{-5}$ |
| ldrne  | $2.559 \times 10^{-3}$ | $2.337 \times 10^{-3}$ | $6.801 \times 10^{-6}$ |
| ble    | $2.529 \times 10^{-3}$ | $1.729 \times 10^{-3}$ | $7.280 \times 10^{-6}$ |
| lsr    | $2.253 \times 10^{-3}$ | $1.638 \times 10^{-3}$ | $1.295 \times 10^{-5}$ |
| bgt    | $2.186 \times 10^{-3}$ | $1.584 \times 10^{-3}$ | $5.758 \times 10^{-6}$ |
| tst    | $2.184 \times 10^{-3}$ | $1.503 \times 10^{-3}$ | $6.701 \times 10^{-6}$ |
| stm    | $2.118 \times 10^{-3}$ | $1.416 \times 10^{-3}$ | $5.763 \times 10^{-6}$ |
| strdeq | $2.043 \times 10^{-3}$ | $1.501 \times 10^{-3}$ | $3.900 \times 10^{-6}$ |
| blt    | $1.901 \times 10^{-3}$ | $1.435 \times 10^{-3}$ | $5.566 \times 10^{-6}$ |
| muleq  | $1.862 \times 10^{-3}$ | $1.304 \times 10^{-3}$ | $3.746 \times 10^{-6}$ |
| ldrdeq | $1.817 \times 10^{-3}$ | $1.290 \times 10^{-3}$ | $3.524 \times 10^{-6}$ |
| cmn    | $1.795 \times 10^{-3}$ | $1.209 \times 10^{-3}$ | $8.513 \times 10^{-6}$ |

|         |                        |                        |                        |
|---------|------------------------|------------------------|------------------------|
| blne    | $1.599 \times 10^{-3}$ | $1.165 \times 10^{-3}$ | $4.849 \times 10^{-6}$ |
| ldrh    | $1.519 \times 10^{-3}$ | $1.013 \times 10^{-3}$ | $8.812 \times 10^{-6}$ |
| asr     | $1.504 \times 10^{-3}$ | $9.891 \times 10^{-4}$ | $4.699 \times 10^{-6}$ |
| strne   | $1.503 \times 10^{-3}$ | $1.423 \times 10^{-3}$ | $3.116 \times 10^{-6}$ |
| bhi     | $1.333 \times 10^{-3}$ | $9.040 \times 10^{-4}$ | $3.734 \times 10^{-6}$ |
| strh    | $1.283 \times 10^{-3}$ | $8.581 \times 10^{-4}$ | $4.988 \times 10^{-6}$ |
| streq   | $1.216 \times 10^{-3}$ | $8.834 \times 10^{-4}$ | $5.139 \times 10^{-6}$ |
| bic     | $1.198 \times 10^{-3}$ | $1.185 \times 10^{-3}$ | $4.174 \times 10^{-6}$ |
| bls     | $1.189 \times 10^{-3}$ | $8.940 \times 10^{-4}$ | $1.858 \times 10^{-6}$ |
| bleq    | $1.162 \times 10^{-3}$ | $9.505 \times 10^{-4}$ | $8.655 \times 10^{-6}$ |
| eor     | $1.122 \times 10^{-3}$ | $8.317 \times 10^{-4}$ | $1.394 \times 10^{-5}$ |
| bge     | $9.826 \times 10^{-4}$ | $6.821 \times 10^{-4}$ | $1.410 \times 10^{-6}$ |
| addne   | $9.023 \times 10^{-4}$ | $6.169 \times 10^{-4}$ | $1.027 \times 10^{-6}$ |
| addeq   | $8.209 \times 10^{-4}$ | $6.386 \times 10^{-4}$ | $3.628 \times 10^{-6}$ |
| adds    | $7.523 \times 10^{-4}$ | $5.253 \times 10^{-4}$ | $2.269 \times 10^{-6}$ |
| bcs     | $7.497 \times 10^{-4}$ | $7.877 \times 10^{-4}$ | $1.119 \times 10^{-6}$ |
| bcc     | $7.177 \times 10^{-4}$ | $5.925 \times 10^{-4}$ | $8.695 \times 10^{-7}$ |
| mul     | $7.094 \times 10^{-4}$ | $4.603 \times 10^{-4}$ | $1.549 \times 10^{-6}$ |
| cmpne   | $5.966 \times 10^{-4}$ | $3.885 \times 10^{-4}$ | $7.388 \times 10^{-7}$ |
| stmia   | $5.899 \times 10^{-4}$ | $4.184 \times 10^{-4}$ | $2.881 \times 10^{-6}$ |
| orrs    | $5.773 \times 10^{-4}$ | $4.530 \times 10^{-4}$ | $9.063 \times 10^{-7}$ |
| movcc   | $5.649 \times 10^{-4}$ | $3.952 \times 10^{-4}$ | $4.613 \times 10^{-7}$ |
| adc     | $5.278 \times 10^{-4}$ | $3.698 \times 10^{-4}$ | $1.933 \times 10^{-6}$ |
| stmdbhi | $4.899 \times 10^{-4}$ | $5.436 \times 10^{-4}$ | $2.087 \times 10^{-5}$ |
| ldrsh   | $4.872 \times 10^{-4}$ | $3.026 \times 10^{-4}$ | $2.260 \times 10^{-6}$ |

|         |                        |                        |                        |
|---------|------------------------|------------------------|------------------------|
| ands    | $4.834 \times 10^{-4}$ | $3.518 \times 10^{-4}$ | $7.610 \times 10^{-7}$ |
| bxne    | $4.589 \times 10^{-4}$ | $3.537 \times 10^{-4}$ | $4.679 \times 10^{-7}$ |
| teq     | $4.428 \times 10^{-4}$ | $3.752 \times 10^{-4}$ | $7.475 \times 10^{-7}$ |
| movle   | $4.333 \times 10^{-4}$ | $2.861 \times 10^{-4}$ | $2.997 \times 10^{-7}$ |
| movge   | $4.090 \times 10^{-4}$ | $2.691 \times 10^{-4}$ | $2.542 \times 10^{-7}$ |
| movgt   | $4.070 \times 10^{-4}$ | $2.585 \times 10^{-4}$ | $3.130 \times 10^{-7}$ |
| movlt   | $4.066 \times 10^{-4}$ | $2.769 \times 10^{-4}$ | $4.069 \times 10^{-7}$ |
| subeq   | $4.022 \times 10^{-4}$ | $3.944 \times 10^{-4}$ | $4.182 \times 10^{-6}$ |
| movcs   | $3.967 \times 10^{-4}$ | $3.225 \times 10^{-4}$ | $5.857 \times 10^{-7}$ |
| rsbs    | $3.799 \times 10^{-4}$ | $2.877 \times 10^{-4}$ | $2.493 \times 10^{-7}$ |
| mlla    | $3.712 \times 10^{-4}$ | $2.215 \times 10^{-4}$ | $8.882 \times 10^{-7}$ |
| stmdami | $3.647 \times 10^{-4}$ | $4.138 \times 10^{-4}$ | $1.184 \times 10^{-5}$ |
| svceq   | $3.487 \times 10^{-4}$ | $4.284 \times 10^{-4}$ | $1.248 \times 10^{-5}$ |
| blhi    | $3.468 \times 10^{-4}$ | $3.883 \times 10^{-4}$ | $1.051 \times 10^{-5}$ |
| stmib   | $3.290 \times 10^{-4}$ | $2.600 \times 10^{-4}$ | $2.620 \times 10^{-7}$ |
| svccc   | $3.258 \times 10^{-4}$ | $2.343 \times 10^{-4}$ | $7.766 \times 10^{-7}$ |
| bxeq    | $3.074 \times 10^{-4}$ | $2.475 \times 10^{-4}$ | $6.612 \times 10^{-7}$ |
| subcs   | $3.061 \times 10^{-4}$ | $2.532 \times 10^{-4}$ | $2.705 \times 10^{-7}$ |
| strgt   | $2.957 \times 10^{-4}$ | $2.606 \times 10^{-4}$ | $1.846 \times 10^{-6}$ |
| mvneq   | $2.517 \times 10^{-4}$ | $2.118 \times 10^{-4}$ | $1.170 \times 10^{-6}$ |
| lsrs    | $2.498 \times 10^{-4}$ | $1.965 \times 10^{-4}$ | $1.748 \times 10^{-7}$ |
| movls   | $2.483 \times 10^{-4}$ | $1.735 \times 10^{-4}$ | $1.290 \times 10^{-7}$ |
| orrne   | $2.436 \times 10^{-4}$ | $1.677 \times 10^{-4}$ | $2.580 \times 10^{-7}$ |
| ldrls   | $2.403 \times 10^{-4}$ | $1.660 \times 10^{-4}$ | $2.027 \times 10^{-7}$ |
| strbeq  | $2.377 \times 10^{-4}$ | $1.950 \times 10^{-4}$ | $3.793 \times 10^{-7}$ |

|        |                        |                        |                        |
|--------|------------------------|------------------------|------------------------|
| strhi  | $2.352 \times 10^{-4}$ | $2.384 \times 10^{-4}$ | $2.755 \times 10^{-6}$ |
| movhi  | $2.345 \times 10^{-4}$ | $1.620 \times 10^{-4}$ | $1.136 \times 10^{-7}$ |
| orrcs  | $2.337 \times 10^{-4}$ | $1.928 \times 10^{-4}$ | $1.599 \times 10^{-7}$ |
| addls  | $2.314 \times 10^{-4}$ | $1.616 \times 10^{-4}$ | $1.840 \times 10^{-7}$ |
| lsls   | $2.292 \times 10^{-4}$ | $1.867 \times 10^{-4}$ | $2.174 \times 10^{-7}$ |
| ldmml  | $2.264 \times 10^{-4}$ | $2.505 \times 10^{-4}$ | $4.588 \times 10^{-6}$ |
| stmdb  | $2.263 \times 10^{-4}$ | $2.549 \times 10^{-4}$ | $4.096 \times 10^{-6}$ |
| strbne | $2.158 \times 10^{-4}$ | $1.513 \times 10^{-4}$ | $1.356 \times 10^{-7}$ |
| ldmmlb | $2.112 \times 10^{-4}$ | $1.900 \times 10^{-4}$ | $2.008 \times 10^{-7}$ |
| eoreq  | $2.035 \times 10^{-4}$ | $1.972 \times 10^{-4}$ | $1.994 \times 10^{-6}$ |
| teqne  | $1.871 \times 10^{-4}$ | $1.583 \times 10^{-4}$ | $1.435 \times 10^{-7}$ |
| strheq | $1.858 \times 10^{-4}$ | $1.487 \times 10^{-4}$ | $3.757 \times 10^{-7}$ |
| addgt  | $1.830 \times 10^{-4}$ | $1.456 \times 10^{-4}$ | $3.793 \times 10^{-7}$ |

## B.2 Motorola 68000 Opcodes

Table B.2: Top 100 opcodes for Motorola 68000

| Mnemonics | Pooled Frequency | Mean Frequency         | Variance               |
|-----------|------------------|------------------------|------------------------|
| movel     | 0.290            | 0.116                  | 0.022                  |
| moveal    | 0.097            | 0.039                  | $2.939 \times 10^{-3}$ |
| bsrl      | 0.085            | 0.033                  | $2.701 \times 10^{-3}$ |
| addql     | 0.049            | 0.019                  | $7.870 \times 10^{-4}$ |
| lea       | 0.042            | 0.017                  | $4.936 \times 10^{-4}$ |
| clrl      | 0.034            | 0.013                  | $3.987 \times 10^{-4}$ |
| pea       | 0.033            | 0.014                  | $4.710 \times 10^{-4}$ |
| tstl      | 0.024            | $9.106 \times 10^{-3}$ | $1.986 \times 10^{-4}$ |

|        |                        |                        |                        |
|--------|------------------------|------------------------|------------------------|
| moveq  | 0.022                  | $8.523 \times 10^{-3}$ | $1.823 \times 10^{-4}$ |
| beqs   | 0.019                  | $7.651 \times 10^{-3}$ | $1.304 \times 10^{-4}$ |
| unlk   | 0.017                  | $7.406 \times 10^{-3}$ | $1.381 \times 10^{-4}$ |
| cmpl   | 0.017                  | $6.295 \times 10^{-3}$ | $9.822 \times 10^{-5}$ |
| rts    | 0.016                  | $6.928 \times 10^{-3}$ | $1.238 \times 10^{-4}$ |
| moveml | 0.015                  | $6.180 \times 10^{-3}$ | $8.564 \times 10^{-5}$ |
| beqw   | 0.015                  | $5.324 \times 10^{-3}$ | $7.299 \times 10^{-5}$ |
| braw   | 0.014                  | $5.177 \times 10^{-3}$ | $7.327 \times 10^{-5}$ |
| jsr    | 0.013                  | $5.442 \times 10^{-3}$ | $2.790 \times 10^{-4}$ |
| bral   | 0.012                  | $5.905 \times 10^{-3}$ | $1.091 \times 10^{-4}$ |
| addl   | 0.011                  | $3.964 \times 10^{-3}$ | $6.882 \times 10^{-5}$ |
| jmp    | 0.011                  | $5.215 \times 10^{-3}$ | $8.536 \times 10^{-5}$ |
| bnes   | 0.010                  | $4.275 \times 10^{-3}$ | $4.674 \times 10^{-5}$ |
| moveb  | 0.010                  | $4.059 \times 10^{-3}$ | $1.182 \times 10^{-4}$ |
| lsl    | $8.356 \times 10^{-3}$ | $2.905 \times 10^{-3}$ | $6.086 \times 10^{-5}$ |
| bras   | $8.014 \times 10^{-3}$ | $3.162 \times 10^{-3}$ | $4.045 \times 10^{-5}$ |
| linkw  | $7.836 \times 10^{-3}$ | $3.549 \times 10^{-3}$ | $3.739 \times 10^{-5}$ |
| bnew   | $7.716 \times 10^{-3}$ | $2.838 \times 10^{-3}$ | $2.253 \times 10^{-5}$ |
| subql  | $7.580 \times 10^{-3}$ | $3.095 \times 10^{-3}$ | $3.782 \times 10^{-5}$ |
| fmoved | $5.470 \times 10^{-3}$ | $1.685 \times 10^{-3}$ | $9.437 \times 10^{-5}$ |
| cmpal  | $5.320 \times 10^{-3}$ | $2.119 \times 10^{-3}$ | $2.496 \times 10^{-5}$ |
| subl   | $4.893 \times 10^{-3}$ | $1.706 \times 10^{-3}$ | $1.713 \times 10^{-5}$ |
| movew  | $4.224 \times 10^{-3}$ | $1.472 \times 10^{-3}$ | $4.281 \times 10^{-5}$ |
| addal  | $4.215 \times 10^{-3}$ | $1.451 \times 10^{-3}$ | $1.467 \times 10^{-5}$ |
| fmoves | $3.371 \times 10^{-3}$ | $1.063 \times 10^{-3}$ | $9.187 \times 10^{-5}$ |

|          |                        |                        |                        |
|----------|------------------------|------------------------|------------------------|
| tstb     | $3.016 \times 10^{-3}$ | $1.239 \times 10^{-3}$ | $8.426 \times 10^{-6}$ |
| addil    | $2.805 \times 10^{-3}$ | $1.173 \times 10^{-3}$ | $1.843 \times 10^{-5}$ |
| btst     | $2.727 \times 10^{-3}$ | $1.012 \times 10^{-3}$ | $1.071 \times 10^{-5}$ |
| moveaw   | $2.153 \times 10^{-3}$ | $8.146 \times 10^{-4}$ | $6.159 \times 10^{-6}$ |
| fmovex   | $2.146 \times 10^{-3}$ | $6.701 \times 10^{-4}$ | $1.437 \times 10^{-5}$ |
| cmpib    | $2.129 \times 10^{-3}$ | $8.261 \times 10^{-4}$ | $7.520 \times 10^{-6}$ |
| andl     | $2.050 \times 10^{-3}$ | $8.185 \times 10^{-4}$ | $9.215 \times 10^{-6}$ |
| clrb     | $2.050 \times 10^{-3}$ | $8.056 \times 10^{-4}$ | $4.084 \times 10^{-6}$ |
| subal    | $1.981 \times 10^{-3}$ | $7.194 \times 10^{-4}$ | $3.034 \times 10^{-6}$ |
| blts     | $1.937 \times 10^{-3}$ | $7.093 \times 10^{-4}$ | $3.400 \times 10^{-6}$ |
| bltw     | $1.803 \times 10^{-3}$ | $6.025 \times 10^{-4}$ | $2.238 \times 10^{-6}$ |
| cmpil    | $1.516 \times 10^{-3}$ | $5.862 \times 10^{-4}$ | $3.454 \times 10^{-6}$ |
| mulsl    | $1.498 \times 10^{-3}$ | $4.490 \times 10^{-4}$ | $3.865 \times 10^{-6}$ |
| orl      | $1.493 \times 10^{-3}$ | $5.255 \times 10^{-4}$ | $4.140 \times 10^{-6}$ |
| asrl     | $1.478 \times 10^{-3}$ | $5.490 \times 10^{-4}$ | $3.028 \times 10^{-6}$ |
| bles     | $1.465 \times 10^{-3}$ | $5.410 \times 10^{-4}$ | $2.239 \times 10^{-6}$ |
| faddx    | $1.436 \times 10^{-3}$ | $4.326 \times 10^{-4}$ | $9.728 \times 10^{-6}$ |
| extbl    | $1.395 \times 10^{-3}$ | $5.095 \times 10^{-4}$ | $1.696 \times 10^{-6}$ |
| andil    | $1.376 \times 10^{-3}$ | $5.504 \times 10^{-4}$ | $4.371 \times 10^{-6}$ |
| blew     | $1.148 \times 10^{-3}$ | $4.061 \times 10^{-4}$ | $1.316 \times 10^{-6}$ |
| bges     | $1.118 \times 10^{-3}$ | $4.301 \times 10^{-4}$ | $1.393 \times 10^{-6}$ |
| fsglmuls | $1.065 \times 10^{-3}$ | $2.869 \times 10^{-4}$ | $1.258 \times 10^{-5}$ |
| fmuld    | $1.052 \times 10^{-3}$ | $3.372 \times 10^{-4}$ | $5.071 \times 10^{-6}$ |
| fmulx    | $1.010 \times 10^{-3}$ | $3.152 \times 10^{-4}$ | $4.181 \times 10^{-6}$ |
| lsrl     | $9.938 \times 10^{-4}$ | $3.779 \times 10^{-4}$ | $2.267 \times 10^{-6}$ |

|          |                        |                        |                        |
|----------|------------------------|------------------------|------------------------|
| clrw     | $9.822 \times 10^{-4}$ | $3.339 \times 10^{-4}$ | $2.638 \times 10^{-6}$ |
| bgtw     | $9.809 \times 10^{-4}$ | $3.689 \times 10^{-4}$ | $1.566 \times 10^{-6}$ |
| bgew     | $9.770 \times 10^{-4}$ | $3.315 \times 10^{-4}$ | $7.113 \times 10^{-7}$ |
| fsubx    | $9.406 \times 10^{-4}$ | $2.630 \times 10^{-4}$ | $4.472 \times 10^{-6}$ |
| negl     | $9.012 \times 10^{-4}$ | $3.287 \times 10^{-4}$ | $8.185 \times 10^{-7}$ |
| fmove1   | $8.524 \times 10^{-4}$ | $3.191 \times 10^{-4}$ | $1.930 \times 10^{-6}$ |
| bccs     | $8.229 \times 10^{-4}$ | $3.250 \times 10^{-4}$ | $9.875 \times 10^{-7}$ |
| bccw     | $7.345 \times 10^{-4}$ | $2.710 \times 10^{-4}$ | $6.021 \times 10^{-7}$ |
| bghts    | $7.191 \times 10^{-4}$ | $2.791 \times 10^{-4}$ | $6.290 \times 10^{-7}$ |
| fmovemx  | $6.675 \times 10^{-4}$ | $2.461 \times 10^{-4}$ | $8.501 \times 10^{-7}$ |
| fadd     | $6.475 \times 10^{-4}$ | $2.254 \times 10^{-4}$ | $2.218 \times 10^{-6}$ |
| swap     | $6.415 \times 10^{-4}$ | $2.239 \times 10^{-4}$ | $2.316 \times 10^{-6}$ |
| bfextu   | $5.953 \times 10^{-4}$ | $2.509 \times 10^{-4}$ | $1.930 \times 10^{-6}$ |
| subxl    | $5.892 \times 10^{-4}$ | $1.955 \times 10^{-4}$ | $7.172 \times 10^{-7}$ |
| eorl     | $5.607 \times 10^{-4}$ | $2.185 \times 10^{-4}$ | $6.544 \times 10^{-6}$ |
| rolw     | $5.584 \times 10^{-4}$ | $1.844 \times 10^{-4}$ | $6.293 \times 10^{-6}$ |
| bcsw     | $5.436 \times 10^{-4}$ | $1.984 \times 10^{-4}$ | $3.320 \times 10^{-7}$ |
| bcss     | $5.086 \times 10^{-4}$ | $1.995 \times 10^{-4}$ | $3.123 \times 10^{-7}$ |
| bhiw     | $4.905 \times 10^{-4}$ | $1.826 \times 10^{-4}$ | $6.445 \times 10^{-7}$ |
| bhis     | $4.900 \times 10^{-4}$ | $2.383 \times 10^{-4}$ | $7.891 \times 10^{-7}$ |
| cmpiw    | $4.871 \times 10^{-4}$ | $1.893 \times 10^{-4}$ | $1.432 \times 10^{-6}$ |
| fsglmulx | $4.868 \times 10^{-4}$ | $1.300 \times 10^{-4}$ | $3.698 \times 10^{-6}$ |
| fadds    | $4.711 \times 10^{-4}$ | $1.551 \times 10^{-4}$ | $3.297 \times 10^{-6}$ |
| notb     | $4.599 \times 10^{-4}$ | $2.304 \times 10^{-4}$ | $2.173 \times 10^{-6}$ |
| oriw     | $4.371 \times 10^{-4}$ | $1.481 \times 10^{-4}$ | $5.150 \times 10^{-7}$ |



|          |                        |                        |                        |
|----------|------------------------|------------------------|------------------------|
| fcmpx    | $4.358 \times 10^{-4}$ | $1.343 \times 10^{-4}$ | $7.121 \times 10^{-7}$ |
| sne      | $4.326 \times 10^{-4}$ | $1.704 \times 10^{-4}$ | $4.352 \times 10^{-7}$ |
| negb     | $4.279 \times 10^{-4}$ | $1.675 \times 10^{-4}$ | $6.346 \times 10^{-7}$ |
| fmovecrx | $4.260 \times 10^{-4}$ | $1.406 \times 10^{-4}$ | $5.662 \times 10^{-7}$ |
| seq      | $4.242 \times 10^{-4}$ | $1.592 \times 10^{-4}$ | $2.551 \times 10^{-7}$ |
| blss     | $4.167 \times 10^{-4}$ | $1.957 \times 10^{-4}$ | $5.667 \times 10^{-7}$ |
| fsubs    | $3.926 \times 10^{-4}$ | $9.743 \times 10^{-5}$ | $2.093 \times 10^{-6}$ |
| fintrzx  | $3.565 \times 10^{-4}$ | $1.383 \times 10^{-4}$ | $4.447 \times 10^{-7}$ |
| fdivx    | $3.502 \times 10^{-4}$ | $1.097 \times 10^{-4}$ | $4.614 \times 10^{-7}$ |
| blsw     | $3.333 \times 10^{-4}$ | $1.206 \times 10^{-4}$ | $4.016 \times 10^{-7}$ |
| addxl    | $3.116 \times 10^{-4}$ | $1.097 \times 10^{-4}$ | $5.899 \times 10^{-7}$ |
| orib     | $3.044 \times 10^{-4}$ | $1.397 \times 10^{-4}$ | $2.177 \times 10^{-7}$ |
| rorl     | $2.780 \times 10^{-4}$ | $8.583 \times 10^{-5}$ | $1.655 \times 10^{-6}$ |
| fcmpd    | $2.779 \times 10^{-4}$ | $8.750 \times 10^{-5}$ | $2.563 \times 10^{-7}$ |
| bclr     | $2.707 \times 10^{-4}$ | $9.441 \times 10^{-5}$ | $3.968 \times 10^{-7}$ |
| notl     | $2.698 \times 10^{-4}$ | $8.058 \times 10^{-5}$ | $1.784 \times 10^{-7}$ |
| bset     | $2.694 \times 10^{-4}$ | $9.131 \times 10^{-5}$ | $3.174 \times 10^{-7}$ |

### B.3 PowerPC Opcodes

Table B.3: Top 100 opcodes for PowerPC

| Mnemonics | Pooled Frequency | Mean Frequency | Variance               |
|-----------|------------------|----------------|------------------------|
| lwz       | 0.202            | 0.111          | 0.013                  |
| mr        | 0.109            | 0.047          | $3.638 \times 10^{-3}$ |
| stw       | 0.108            | 0.068          | $5.599 \times 10^{-3}$ |
| bl        | 0.074            | 0.034          | $2.345 \times 10^{-3}$ |

|        |                        |                        |                        |
|--------|------------------------|------------------------|------------------------|
| addi   | 0.073                  | 0.045                  | $2.351 \times 10^{-3}$ |
| li     | 0.044                  | 0.023                  | $7.311 \times 10^{-4}$ |
| b      | 0.038                  | 0.018                  | $5.380 \times 10^{-4}$ |
| cmpwi  | 0.032                  | 0.014                  | $3.524 \times 10^{-4}$ |
| beq    | 0.027                  | 0.012                  | $2.235 \times 10^{-4}$ |
| mtctr  | 0.026                  | 0.017                  | $4.833 \times 10^{-4}$ |
| bne    | 0.020                  | $9.697 \times 10^{-3}$ | $1.700 \times 10^{-4}$ |
| nop    | 0.019                  | $8.615 \times 10^{-3}$ | $1.369 \times 10^{-4}$ |
| mflr   | 0.017                  | $9.835 \times 10^{-3}$ | $1.552 \times 10^{-4}$ |
| bctrl  | 0.013                  | 0.012                  | $4.702 \times 10^{-4}$ |
| blr    | 0.013                  | $8.461 \times 10^{-3}$ | $1.139 \times 10^{-4}$ |
| mtlr   | 0.012                  | $7.778 \times 10^{-3}$ | $8.292 \times 10^{-5}$ |
| bctr   | 0.012                  | $4.531 \times 10^{-3}$ | $7.371 \times 10^{-5}$ |
| stwu   | 0.010                  | $7.333 \times 10^{-3}$ | $9.559 \times 10^{-5}$ |
| lis    | $9.770 \times 10^{-3}$ | 0.013                  | $7.895 \times 10^{-4}$ |
| rlwinm | $9.489 \times 10^{-3}$ | $3.524 \times 10^{-3}$ | $5.770 \times 10^{-5}$ |
| add    | $8.205 \times 10^{-3}$ | $2.879 \times 10^{-3}$ | $5.858 \times 10^{-5}$ |
| cmpw   | $8.003 \times 10^{-3}$ | $4.084 \times 10^{-3}$ | $3.572 \times 10^{-5}$ |
| stfd   | $7.871 \times 10^{-3}$ | $7.067 \times 10^{-3}$ | $2.998 \times 10^{-4}$ |
| addis  | $7.860 \times 10^{-3}$ | $3.178 \times 10^{-3}$ | $3.096 \times 10^{-5}$ |
| bcl    | $7.266 \times 10^{-3}$ | $2.724 \times 10^{-3}$ | $2.729 \times 10^{-5}$ |
| crclr  | $6.774 \times 10^{-3}$ | $4.746 \times 10^{-3}$ | $1.052 \times 10^{-4}$ |
| lbz    | $6.136 \times 10^{-3}$ | $3.941 \times 10^{-3}$ | $1.786 \times 10^{-4}$ |
| stwex  | $4.964 \times 10^{-3}$ | $1.825 \times 10^{-3}$ | $4.354 \times 10^{-5}$ |
| lwarx  | $4.564 \times 10^{-3}$ | $1.653 \times 10^{-3}$ | $4.216 \times 10^{-5}$ |

|        |                        |                        |                        |
|--------|------------------------|------------------------|------------------------|
| stb    | $4.291 \times 10^{-3}$ | $3.280 \times 10^{-3}$ | $3.405 \times 10^{-5}$ |
| lfd    | $3.448 \times 10^{-3}$ | $1.184 \times 10^{-3}$ | $2.480 \times 10^{-5}$ |
| lfs    | $3.392 \times 10^{-3}$ | $1.202 \times 10^{-3}$ | $5.700 \times 10^{-5}$ |
| subf   | $3.209 \times 10^{-3}$ | $1.165 \times 10^{-3}$ | $9.922 \times 10^{-6}$ |
| ble    | $3.073 \times 10^{-3}$ | $1.129 \times 10^{-3}$ | $7.246 \times 10^{-6}$ |
| cmplw  | $2.683 \times 10^{-3}$ | $1.620 \times 10^{-3}$ | $1.148 \times 10^{-5}$ |
| blt    | $2.656 \times 10^{-3}$ | $1.389 \times 10^{-3}$ | $7.657 \times 10^{-6}$ |
| bgt    | $2.588 \times 10^{-3}$ | $1.371 \times 10^{-3}$ | $7.484 \times 10^{-6}$ |
| bge    | $2.273 \times 10^{-3}$ | $1.280 \times 10^{-3}$ | $5.075 \times 10^{-6}$ |
| addic  | $2.220 \times 10^{-3}$ | $1.092 \times 10^{-3}$ | $2.152 \times 10^{-5}$ |
| lwzx   | $2.023 \times 10^{-3}$ | $6.462 \times 10^{-4}$ | $1.021 \times 10^{-5}$ |
| cmplwi | $1.807 \times 10^{-3}$ | $1.805 \times 10^{-3}$ | $2.347 \times 10^{-5}$ |
| clrlwi | $1.786 \times 10^{-3}$ | $8.320 \times 10^{-4}$ | $1.253 \times 10^{-5}$ |
| srawi  | $1.384 \times 10^{-3}$ | $4.760 \times 10^{-4}$ | $3.472 \times 10^{-6}$ |
| ori    | $1.162 \times 10^{-3}$ | $5.370 \times 10^{-4}$ | $3.536 \times 10^{-6}$ |
| lhz    | $1.146 \times 10^{-3}$ | $5.335 \times 10^{-4}$ | $4.565 \times 10^{-6}$ |
| andi   | $1.086 \times 10^{-3}$ | $3.824 \times 10^{-4}$ | $2.223 \times 10^{-6}$ |
| fmr    | $1.062 \times 10^{-3}$ | $3.259 \times 10^{-4}$ | $6.725 \times 10^{-6}$ |
| mullw  | $1.023 \times 10^{-3}$ | $2.847 \times 10^{-4}$ | $2.326 \times 10^{-6}$ |
| fsub   | $1.005 \times 10^{-3}$ | $3.247 \times 10^{-4}$ | $2.998 \times 10^{-6}$ |
| sth    | $9.405 \times 10^{-4}$ | $4.463 \times 10^{-4}$ | $4.584 \times 10^{-6}$ |
| or     | $9.313 \times 10^{-4}$ | $2.989 \times 10^{-4}$ | $4.820 \times 10^{-6}$ |
| lwzu   | $8.468 \times 10^{-4}$ | $5.458 \times 10^{-4}$ | $1.762 \times 10^{-5}$ |
| stfs   | $8.220 \times 10^{-4}$ | $2.412 \times 10^{-4}$ | $8.398 \times 10^{-6}$ |
| dozi   | $7.581 \times 10^{-4}$ | $5.424 \times 10^{-4}$ | $2.884 \times 10^{-5}$ |

|        |                        |                        |                        |
|--------|------------------------|------------------------|------------------------|
| fmul   | $7.353 \times 10^{-4}$ | $2.018 \times 10^{-4}$ | $2.158 \times 10^{-6}$ |
| fcmpu  | $6.459 \times 10^{-4}$ | $1.944 \times 10^{-4}$ | $1.237 \times 10^{-6}$ |
| andis  | $6.173 \times 10^{-4}$ | $3.786 \times 10^{-4}$ | $9.402 \times 10^{-6}$ |
| xoris  | $6.155 \times 10^{-4}$ | $2.820 \times 10^{-4}$ | $1.948 \times 10^{-6}$ |
| subfic | $5.699 \times 10^{-4}$ | $3.658 \times 10^{-4}$ | $9.345 \times 10^{-6}$ |
| mtrcf  | $5.698 \times 10^{-4}$ | $1.911 \times 10^{-4}$ | $3.593 \times 10^{-7}$ |
| mfcf   | $5.549 \times 10^{-4}$ | $2.314 \times 10^{-4}$ | $6.434 \times 10^{-7}$ |
| twi    | $5.389 \times 10^{-4}$ | $4.331 \times 10^{-4}$ | $1.693 \times 10^{-5}$ |
| stwx   | $5.047 \times 10^{-4}$ | $1.804 \times 10^{-4}$ | $4.760 \times 10^{-7}$ |
| lfsu   | $5.036 \times 10^{-4}$ | $3.590 \times 10^{-4}$ | $1.200 \times 10^{-5}$ |
| bdnz   | $4.941 \times 10^{-4}$ | $1.509 \times 10^{-4}$ | $4.702 \times 10^{-7}$ |
| stmw   | $4.371 \times 10^{-4}$ | $3.858 \times 10^{-4}$ | $1.737 \times 10^{-5}$ |
| xor    | $4.319 \times 10^{-4}$ | $1.609 \times 10^{-4}$ | $2.251 \times 10^{-6}$ |
| lha    | $4.266 \times 10^{-4}$ | $2.248 \times 10^{-4}$ | $4.639 \times 10^{-6}$ |
| isync  | $4.260 \times 10^{-4}$ | $1.851 \times 10^{-4}$ | $1.678 \times 10^{-6}$ |
| bla    | $4.181 \times 10^{-4}$ | $3.057 \times 10^{-4}$ | $8.940 \times 10^{-6}$ |
| fadd   | $4.175 \times 10^{-4}$ | $1.275 \times 10^{-4}$ | $1.046 \times 10^{-6}$ |
| fadds  | $4.122 \times 10^{-4}$ | $5.933 \times 10^{-5}$ | $3.736 \times 10^{-6}$ |
| xori   | $3.862 \times 10^{-4}$ | $1.772 \times 10^{-4}$ | $5.411 \times 10^{-7}$ |
| fmadd  | $3.835 \times 10^{-4}$ | $9.789 \times 10^{-5}$ | $8.422 \times 10^{-7}$ |
| neg    | $3.727 \times 10^{-4}$ | $1.168 \times 10^{-4}$ | $3.035 \times 10^{-7}$ |
| fddiv  | $3.705 \times 10^{-4}$ | $1.137 \times 10^{-4}$ | $7.415 \times 10^{-7}$ |
| rlwimi | $3.666 \times 10^{-4}$ | $1.698 \times 10^{-4}$ | $1.333 \times 10^{-6}$ |
| fsubs  | $3.565 \times 10^{-4}$ | $5.150 \times 10^{-5}$ | $3.237 \times 10^{-6}$ |
| lbzx   | $3.494 \times 10^{-4}$ | $1.820 \times 10^{-4}$ | $9.695 \times 10^{-7}$ |

|        |                        |                        |                        |
|--------|------------------------|------------------------|------------------------|
| lwsync | $3.489 \times 10^{-4}$ | $1.483 \times 10^{-4}$ | $1.341 \times 10^{-6}$ |
| lbzu   | $3.469 \times 10^{-4}$ | $2.509 \times 10^{-4}$ | $4.184 \times 10^{-6}$ |
| lfdx   | $3.433 \times 10^{-4}$ | $9.182 \times 10^{-5}$ | $7.644 \times 10^{-7}$ |
| oris   | $3.404 \times 10^{-4}$ | $2.281 \times 10^{-4}$ | $3.907 \times 10^{-6}$ |
| fmuls  | $3.230 \times 10^{-4}$ | $5.681 \times 10^{-5}$ | $1.146 \times 10^{-6}$ |
| fmadds | $3.022 \times 10^{-4}$ | $5.604 \times 10^{-5}$ | $1.203 \times 10^{-6}$ |
| stbx   | $2.920 \times 10^{-4}$ | $9.600 \times 10^{-5}$ | $6.106 \times 10^{-7}$ |
| lmw    | $2.788 \times 10^{-4}$ | $2.261 \times 10^{-4}$ | $5.257 \times 10^{-6}$ |
| subfe  | $2.762 \times 10^{-4}$ | $1.000 \times 10^{-4}$ | $2.106 \times 10^{-7}$ |
| and    | $2.607 \times 10^{-4}$ | $9.626 \times 10^{-5}$ | $5.368 \times 10^{-7}$ |
| fctiwz | $2.603 \times 10^{-4}$ | $8.791 \times 10^{-5}$ | $2.696 \times 10^{-7}$ |
| extsh  | $2.263 \times 10^{-4}$ | $8.447 \times 10^{-5}$ | $2.095 \times 10^{-6}$ |
| stfdx  | $2.248 \times 10^{-4}$ | $5.552 \times 10^{-5}$ | $3.453 \times 10^{-7}$ |
| cmpi   | $2.189 \times 10^{-4}$ | $1.667 \times 10^{-4}$ | $2.691 \times 10^{-6}$ |
| cntlzw | $2.173 \times 10^{-4}$ | $7.179 \times 10^{-5}$ | $9.951 \times 10^{-8}$ |
| rotlwi | $2.173 \times 10^{-4}$ | $7.879 \times 10^{-5}$ | $9.542 \times 10^{-7}$ |
| ba     | $1.968 \times 10^{-4}$ | $1.482 \times 10^{-4}$ | $2.053 \times 10^{-6}$ |
| rlwnm  | $1.829 \times 10^{-4}$ | $1.411 \times 10^{-4}$ | $1.811 \times 10^{-6}$ |
| addze  | $1.802 \times 10^{-4}$ | $6.972 \times 10^{-5}$ | $1.433 \times 10^{-7}$ |
| lhzx   | $1.748 \times 10^{-4}$ | $5.453 \times 10^{-5}$ | $1.048 \times 10^{-7}$ |
| mcrf   | $1.714 \times 10^{-4}$ | $6.664 \times 10^{-5}$ | $5.635 \times 10^{-7}$ |

## B.4 AVR Opcodes

Table B.4: Top 100 opcodes for AVR

| Mnemonics | Pooled Frequency | Mean Frequency | Variance               |
|-----------|------------------|----------------|------------------------|
| sbc       | 0.104            | 0.087          | $2.385 \times 10^{-3}$ |
| sbc_i     | 0.065            | 0.054          | $9.367 \times 10^{-4}$ |
| rjmp      | 0.065            | 0.054          | $9.958 \times 10^{-4}$ |
| ori       | 0.059            | 0.049          | $1.322 \times 10^{-3}$ |
| cpi       | 0.054            | 0.045          | $5.534 \times 10^{-4}$ |
| ldd       | 0.054            | 0.043          | $6.339 \times 10^{-4}$ |
| cp        | 0.046            | 0.041          | $1.398 \times 10^{-3}$ |
| ldi       | 0.040            | 0.031          | $5.693 \times 10^{-4}$ |
| sub       | 0.038            | 0.032          | $4.133 \times 10^{-4}$ |
| rcall     | 0.037            | 0.031          | $3.833 \times 10^{-4}$ |
| subi      | 0.036            | 0.030          | $2.620 \times 10^{-4}$ |
| andi      | 0.035            | 0.028          | $3.138 \times 10^{-4}$ |
| add       | 0.033            | 0.028          | $4.953 \times 10^{-4}$ |
| or        | 0.030            | 0.026          | $3.344 \times 10^{-4}$ |
| mul       | 0.026            | 0.022          | $3.080 \times 10^{-4}$ |
| std       | 0.024            | 0.020          | $1.476 \times 10^{-4}$ |
| cpc       | 0.021            | 0.018          | $1.791 \times 10^{-4}$ |
| in        | 0.018            | 0.014          | $1.343 \times 10^{-4}$ |
| adc       | 0.018            | 0.015          | $2.156 \times 10^{-4}$ |
| out       | 0.018            | 0.015          | $7.890 \times 10^{-5}$ |
| mov       | 0.016            | 0.014          | $2.544 \times 10^{-4}$ |
| nop       | 0.013            | 0.012          | $1.165 \times 10^{-3}$ |

|       |                        |                        |                        |
|-------|------------------------|------------------------|------------------------|
| eor   | 0.013                  | 0.011                  | $5.447 \times 10^{-5}$ |
| ld    | 0.013                  | 0.010                  | $5.450 \times 10^{-5}$ |
| sbis  | 0.011                  | $9.558 \times 10^{-3}$ | $7.980 \times 10^{-5}$ |
| cbi   | 0.010                  | $8.018 \times 10^{-3}$ | $4.731 \times 10^{-5}$ |
| mul   | $9.442 \times 10^{-3}$ | $8.021 \times 10^{-3}$ | $9.234 \times 10^{-5}$ |
| and   | $9.347 \times 10^{-3}$ | $7.766 \times 10^{-3}$ | $5.623 \times 10^{-5}$ |
| cpse  | $9.055 \times 10^{-3}$ | $7.506 \times 10^{-3}$ | $2.756 \times 10^{-5}$ |
| sbic  | $7.840 \times 10^{-3}$ | $6.164 \times 10^{-3}$ | $2.548 \times 10^{-5}$ |
| sbi   | $7.138 \times 10^{-3}$ | $5.929 \times 10^{-3}$ | $2.624 \times 10^{-5}$ |
| bld   | $6.306 \times 10^{-3}$ | $5.145 \times 10^{-3}$ | $1.895 \times 10^{-5}$ |
| mulsu | $5.309 \times 10^{-3}$ | $4.491 \times 10^{-3}$ | $4.397 \times 10^{-5}$ |
| movw  | $4.265 \times 10^{-3}$ | $3.753 \times 10^{-3}$ | $3.453 \times 10^{-5}$ |
| fmuls | $4.208 \times 10^{-3}$ | $3.677 \times 10^{-3}$ | $1.667 \times 10^{-5}$ |
| brid  | $3.478 \times 10^{-3}$ | $2.845 \times 10^{-3}$ | $2.712 \times 10^{-5}$ |
| bst   | $3.036 \times 10^{-3}$ | $2.418 \times 10^{-3}$ | $7.188 \times 10^{-6}$ |
| sbrc  | $2.876 \times 10^{-3}$ | $2.338 \times 10^{-3}$ | $4.079 \times 10^{-6}$ |
| sbiw  | $2.459 \times 10^{-3}$ | $2.145 \times 10^{-3}$ | $1.224 \times 10^{-5}$ |
| brie  | $2.177 \times 10^{-3}$ | $1.674 \times 10^{-3}$ | $1.073 \times 10^{-5}$ |
| reti  | $2.175 \times 10^{-3}$ | $1.957 \times 10^{-3}$ | $8.058 \times 10^{-6}$ |
| sbrs  | $2.096 \times 10^{-3}$ | $1.753 \times 10^{-3}$ | $2.608 \times 10^{-6}$ |
| brtc  | $1.586 \times 10^{-3}$ | $1.276 \times 10^{-3}$ | $7.550 \times 10^{-7}$ |
| lds   | $1.362 \times 10^{-3}$ | $1.178 \times 10^{-3}$ | $1.097 \times 10^{-6}$ |
| st    | $1.293 \times 10^{-3}$ | $1.035 \times 10^{-3}$ | $1.284 \times 10^{-6}$ |
| brcs  | $1.125 \times 10^{-3}$ | $9.175 \times 10^{-4}$ | $7.523 \times 10^{-7}$ |
| adiw  | $9.635 \times 10^{-4}$ | $7.981 \times 10^{-4}$ | $8.986 \times 10^{-7}$ |

|        |                        |                        |                        |
|--------|------------------------|------------------------|------------------------|
| brcc   | $9.431 \times 10^{-4}$ | $7.666 \times 10^{-4}$ | $5.165 \times 10^{-7}$ |
| com    | $9.159 \times 10^{-4}$ | $7.624 \times 10^{-4}$ | $1.038 \times 10^{-6}$ |
| brge   | $8.191 \times 10^{-4}$ | $6.825 \times 10^{-4}$ | $1.273 \times 10^{-6}$ |
| brpl   | $6.745 \times 10^{-4}$ | $4.987 \times 10^{-4}$ | $1.240 \times 10^{-6}$ |
| brts   | $6.722 \times 10^{-4}$ | $5.077 \times 10^{-4}$ | $5.239 \times 10^{-7}$ |
| call   | $6.439 \times 10^{-4}$ | $5.019 \times 10^{-4}$ | $4.210 \times 10^{-7}$ |
| lsr    | $5.972 \times 10^{-4}$ | $5.139 \times 10^{-4}$ | $7.079 \times 10^{-7}$ |
| brlt   | $5.814 \times 10^{-4}$ | $4.785 \times 10^{-4}$ | $3.682 \times 10^{-7}$ |
| brmi   | $5.801 \times 10^{-4}$ | $4.453 \times 10^{-4}$ | $5.859 \times 10^{-7}$ |
| breq   | $5.439 \times 10^{-4}$ | $4.308 \times 10^{-4}$ | $1.523 \times 10^{-7}$ |
| lpm    | $5.237 \times 10^{-4}$ | $4.079 \times 10^{-4}$ | $3.063 \times 10^{-7}$ |
| fmulsu | $5.087 \times 10^{-4}$ | $3.623 \times 10^{-4}$ | $4.949 \times 10^{-6}$ |
| elpm   | $5.001 \times 10^{-4}$ | $3.833 \times 10^{-4}$ | $3.070 \times 10^{-7}$ |
| sez    | $4.419 \times 10^{-4}$ | $4.118 \times 10^{-4}$ | $7.592 \times 10^{-7}$ |
| fmul   | $4.410 \times 10^{-4}$ | $3.721 \times 10^{-4}$ | $3.549 \times 10^{-7}$ |
| brne   | $4.348 \times 10^{-4}$ | $3.451 \times 10^{-4}$ | $1.043 \times 10^{-7}$ |
| sts    | $4.328 \times 10^{-4}$ | $3.529 \times 10^{-4}$ | $2.655 \times 10^{-7}$ |
| pop    | $4.248 \times 10^{-4}$ | $3.735 \times 10^{-4}$ | $2.648 \times 10^{-7}$ |
| brvs   | $3.635 \times 10^{-4}$ | $2.917 \times 10^{-4}$ | $9.149 \times 10^{-8}$ |
| brhs   | $3.463 \times 10^{-4}$ | $2.802 \times 10^{-4}$ | $1.144 \times 10^{-7}$ |
| swap   | $3.318 \times 10^{-4}$ | $2.687 \times 10^{-4}$ | $9.724 \times 10^{-8}$ |
| brvc   | $3.075 \times 10^{-4}$ | $2.424 \times 10^{-4}$ | $7.947 \times 10^{-8}$ |
| brhc   | $2.478 \times 10^{-4}$ | $1.962 \times 10^{-4}$ | $1.075 \times 10^{-7}$ |
| neg    | $2.477 \times 10^{-4}$ | $2.012 \times 10^{-4}$ | $8.293 \times 10^{-8}$ |
| jmp    | $1.839 \times 10^{-4}$ | $1.492 \times 10^{-4}$ | $1.047 \times 10^{-7}$ |



|        |                        |                        |                         |
|--------|------------------------|------------------------|-------------------------|
| dec    | $1.764 \times 10^{-4}$ | $1.541 \times 10^{-4}$ | $1.180 \times 10^{-7}$  |
| inc    | $1.181 \times 10^{-4}$ | $9.001 \times 10^{-5}$ | $1.272 \times 10^{-8}$  |
| push   | $8.242 \times 10^{-5}$ | $6.645 \times 10^{-5}$ | $9.349 \times 10^{-9}$  |
| asr    | $7.927 \times 10^{-5}$ | $6.237 \times 10^{-5}$ | $1.677 \times 10^{-8}$  |
| ror    | $6.192 \times 10^{-5}$ | $4.858 \times 10^{-5}$ | $6.359 \times 10^{-9}$  |
| des    | $3.839 \times 10^{-5}$ | $2.886 \times 10^{-5}$ | $2.372 \times 10^{-9}$  |
| ret    | $3.434 \times 10^{-5}$ | $2.810 \times 10^{-5}$ | $4.994 \times 10^{-9}$  |
| sec    | $3.327 \times 10^{-5}$ | $1.850 \times 10^{-5}$ | $3.804 \times 10^{-8}$  |
| cli    | $1.864 \times 10^{-5}$ | $1.352 \times 10^{-5}$ | $2.940 \times 10^{-9}$  |
| ijmp   | $1.395 \times 10^{-5}$ | $1.111 \times 10^{-5}$ | $6.020 \times 10^{-10}$ |
| spm    | $3.679 \times 10^{-6}$ | $2.804 \times 10^{-6}$ | $1.093 \times 10^{-10}$ |
| eijmp  | $2.648 \times 10^{-6}$ | $1.987 \times 10^{-6}$ | $5.490 \times 10^{-10}$ |
| seh    | $2.435 \times 10^{-6}$ | $1.885 \times 10^{-6}$ | $1.051 \times 10^{-10}$ |
| set    | $1.635 \times 10^{-6}$ | $1.363 \times 10^{-6}$ | $2.877 \times 10^{-10}$ |
| icall  | $1.564 \times 10^{-6}$ | $1.347 \times 10^{-6}$ | $6.965 \times 10^{-11}$ |
| sev    | $1.351 \times 10^{-6}$ | $8.481 \times 10^{-7}$ | $6.810 \times 10^{-11}$ |
| eicall | $1.244 \times 10^{-6}$ | $1.017 \times 10^{-6}$ | $4.951 \times 10^{-11}$ |
| sen    | $1.155 \times 10^{-6}$ | $1.169 \times 10^{-6}$ | $8.271 \times 10^{-11}$ |
| cls    | $1.137 \times 10^{-6}$ | $9.571 \times 10^{-7}$ | $3.885 \times 10^{-11}$ |
| clt    | $1.120 \times 10^{-6}$ | $8.592 \times 10^{-7}$ | $3.774 \times 10^{-11}$ |
| clv    | $1.031 \times 10^{-6}$ | $7.319 \times 10^{-7}$ | $3.336 \times 10^{-11}$ |
| wdr    | $9.775 \times 10^{-7}$ | $6.419 \times 10^{-7}$ | $2.563 \times 10^{-11}$ |
| clc    | $9.242 \times 10^{-7}$ | $7.735 \times 10^{-7}$ | $3.412 \times 10^{-11}$ |
| clz    | $9.242 \times 10^{-7}$ | $7.356 \times 10^{-7}$ | $4.751 \times 10^{-11}$ |
| sei    | $9.242 \times 10^{-7}$ | $7.487 \times 10^{-7}$ | $4.463 \times 10^{-11}$ |

|     |                        |                        |                         |
|-----|------------------------|------------------------|-------------------------|
| cln | $9.064 \times 10^{-7}$ | $7.463 \times 10^{-7}$ | $6.100 \times 10^{-11}$ |
| clh | $8.531 \times 10^{-7}$ | $5.739 \times 10^{-7}$ | $2.052 \times 10^{-11}$ |
| ses | $8.531 \times 10^{-7}$ | $6.768 \times 10^{-7}$ | $3.306 \times 10^{-11}$ |

## Bibliography

- [1] M. Abrams and J. Weiss. *Bellingham, Washington, Control System Cyber Security Case Study*. Technical report, MITRE, August 2007. [http://csrc.nist.gov/groups/SMA/fisma/ics/documents/Bellingham\\_Case\\_Study\\_report%2020Sep071.pdf](http://csrc.nist.gov/groups/SMA/fisma/ics/documents/Bellingham_Case_Study_report%2020Sep071.pdf). 4 Feb 2013.
- [2] M. Abrams and J. Weiss. *Malicious Control System Cyber Security Attack Case Study – Maroochy Water Services, Australia*. Case Study 08-1145, MITRE, August 2008. [http://csrc.nist.gov/groups/SMA/fisma/ics/documents/Maroochy-Water-Services-Case-Study\\_report.pdf](http://csrc.nist.gov/groups/SMA/fisma/ics/documents/Maroochy-Water-Services-Case-Study_report.pdf). 4 Feb 2013.
- [3] R. Akkiraju, T. Mitra, and U. Thulasiram. “Reverse Engineering Platform Independent Models from Business Software Applications”. *Reverse Engineering - Recent Advances and Applications*, 83–94. InTech Press, March 2012.
- [4] I. Albert. “python-statlib: Descriptive statistics for the python programming language”, December 2007. <http://code.google.com/p/python-statlib/>. 4 Feb 2013.
- [5] M. C. Amirani et al. “A new approach to content-based file type detection”. *IEEE Symposium on Computers and Communications*, 1103–1108. July 2008. <http://dx.doi.org/10.1109/ISCC.2008.4625611>. 4 Feb 2013.
- [6] ARM Limited. *ARM Developer Suite Version 1.2 Developer Guide*. Technical Report ARM DUI 0056D, November 2001. <http://lyle.smu.edu/~mitch/class/5385/ADS-Dev-Guide-DUI0056.pdf>. 4 Feb 2013.
- [7] S. Axelsson. “Using Normalized Compression Distance for Classifying File Fragments”. *ARES '10 International Conference on Availability, Reliability, and Security*, 641–646. February 2010. <http://dx.doi.org/10.1109/ARES.2010.100>. 4 Feb 2013.
- [8] D. Barr. *Supervisory Control and Data Acquisition (SCADA) Systems*. Technical Report NCS TIB 04-1, National Communications System, October 2004.
- [9] N. Beebe. “Digital Forensic Research: The Good, the Bad and the Unaddressed”. Gilbert Peterson and Sujeet Sheno (editors), *Advances in Digital Forensics V*, volume 306 of *IFIP Advances in Information and Communication Technology*, 17–36. Springer Boston, 2009. [http://dx.doi.org/10.1007/978-3-642-04155-6\\_2](http://dx.doi.org/10.1007/978-3-642-04155-6_2). 4 Feb 2013.
- [10] G. W. Bush. *Critical infrastructure identification, prioritization, and protection*. Homeland Security Presidential Directive HSPD-7, White House, Washington, December 2003. <http://www.dhs.gov/homeland-security-presidential-directive-7#1>. 4 Feb 2013.

- [11] E. Byres, A. Ginter, and J. Langill. *How Stuxnet Spreads - A Study of Infection Paths in Best Practice Systems*. Technical report, Tofino Security, 2011.
- [12] W. C. Calhoun and D. Coles. “Predicting the types of file fragments”. *Digital Investigation*, 5S(0):S14–S20, September 2008. <http://www.sciencedirect.com/science/article/pii/S1742287608000273>. 4 Feb 2013.
- [13] W. J. Clinton. *Critical Infrastructure Protection*. Presidential Decision Directive PDD-63, White House, Washington, May 1998. <http://www.fas.org/irp/offdocs/pdd/pdd-63.htm>. 4 Feb 2013.
- [14] CompuServe Incorporated. *GIF: Graphics Interchange Format*. Technical Report gif87a, June 1987. <http://www.w3.org/Graphics/GIF/spec-gif87.txt>. 4 Feb 2013.
- [15] G. Conti et al. “Automated mapping of large binary objects using primitive fragment type classification”. *Digital Investigation*, 7S(0):S3–S12, August 2010. <http://www.sciencedirect.com/science/article/pii/S1742287610000290>. 4 Feb 2013.
- [16] B. Copy and F. Tilaro. “Standards based measurable security for embedded devices”. *Proceedings of the 12th International Conference on Accelerator and Large Experimental Physics Control Systems*. October 2009.
- [17] A. Cutts. “Warfare and the Continuum of Cyber Risks: A Policy Perspective”. *The Virtual Battlefield: Perspectives on Cyber Warfare*, 66–76. IOS Press, 2009.
- [18] I. Dacosta et al. “Security Analysis of an IP Phone: Cisco 7960G”. Henning Schulzrinne et al. (editors), *Principles, Systems and Applications of IP Telecommunications. Services and Security for Next Generation Networks*, 236–255. Springer-Verlag, Berlin, Heidelberg, 2008. [http://dx.doi.org/10.1007/978-3-540-89054-6\\_12](http://dx.doi.org/10.1007/978-3-540-89054-6_12). 4 Feb 2013.
- [19] G. Delugré. “Closer to Metal: Reverse engineering the Broadcom NetExtreme’s Firmware”, October 2010. [http://esec-lab.sogeti.com/dotclear/public/publications/10-hack.lu-nicreverse\\_slides.pdf](http://esec-lab.sogeti.com/dotclear/public/publications/10-hack.lu-nicreverse_slides.pdf). 4 Feb 2013.
- [20] P. Deutsch. *GZIP file format specification version 4.3*. Request for Comments 1952, Network Working Group, May 1996. <http://tools.ietf.org/html/rfc1952>. 4 Feb 2013.
- [21] P. Deutsch and J.-L. Gailly. *ZLIB Compressed Data Format Specification version 3.3*. Request for Comments 1950, Network Working Group, May 1996. <http://tools.ietf.org/html/rfc1950>. 4 Feb 2013.
- [22] D. Douglas and T. Peucker. “Algorithms for the reduction of the number of points required to represent a digitized line or its caricature”. *Cartographica: The International Journal for Geographic Information and Geovisualization*, 10(2):112–122, 1973.

- [23] R. F. Erbacher and J. Mulholland. “Identification and localization of data types within large-scale file systems”. *Systematic Approaches to Digital Forensic Engineering, 2007. SADFE 2007. Second International Workshop on*, 55–70. IEEE, 2007.
- [24] N. Falliere, L. O. Murchu, and E. Chien. *W32.Stuxnet Dossier*. Technical report, Symantec, February 2011.
- [25] S. Fogie. “Embedded reverse engineering: Cracking mobile binaries”. *CodeBreakers Magazine*, 1(1), January 2006.
- [26] Free Software Foundation. “GNU Binutils”, August 2007. <http://www.gnu.org/software/binutils/>. 4 Feb 2013.
- [27] S. Garfinkel et al. “Bringing Science to Digital Forensics with Standardized Forensic Corpora”. *Digital Investigation*, 6:S2–S11, 2009.
- [28] J. Grand. “Introduction to embedded security”, July 2004. [http://www.blackhat.com/presentations/bh-usa-04/bh-us-04-grand/grand\\_embedded\\_security\\_US04.pdf](http://www.blackhat.com/presentations/bh-usa-04/bh-us-04-grand/grand_embedded_security_US04.pdf). 4 Feb 2013.
- [29] T. Hurman. *Exploring Windows CE shellcode*. Technical report, Pentest Limited, June 2005.
- [30] International Business Machines. *PowerPC Microprocessor Family: The Programming Environments for 32-Bit Microprocessors*. Technical Report G522-0290-01, February 2000. [https://www-01.ibm.com/chips/techlib/techlib.nsf/techdocs/852569B20050FF778525699600719DF2/%24file/6xx\\_pem.pdf](https://www-01.ibm.com/chips/techlib/techlib.nsf/techdocs/852569B20050FF778525699600719DF2/%24file/6xx_pem.pdf). 4 Feb 2013.
- [31] International Electrotechnical Commission. *IEC61131-3 - Programmable Controllers - Part 3: Programming Languages*. International Electrotechnical Commission, Geneva, second edition, January 2003.
- [32] M. Karresand and N. Shahmehri. “File Type Identification of Data Fragments by Their Binary Structure”. *Information Assurance Workshop, 2006 IEEE*, 140–147. June 2006. <http://dx.doi.org/10.1109/IAW.2006.1652088>. 4 Feb 2013.
- [33] M. Karresand and N. Shahmehri. “Oscar - File Type Identification of Binary Data in Disk Clusters and RAM Pages”. Fischer-Hübner et al. (editors), *Security and Privacy in Dynamic Environments*, volume 201 of *IFIP International Federation for Information Processing*, 413–424. Springer Boston, 2006. [http://dx.doi.org/10.1007/0-387-33406-8\\_35](http://dx.doi.org/10.1007/0-387-33406-8_35). 4 Feb 2013.
- [34] J. Kleinberg and É. Tardos. *Algorithm Design*. Addison-Wesley, 2006.
- [35] J. Z. Kolter and M. A. Maloof. “Learning to Detect and Classify Malicious Executables in the Wild”. *Journal of Machine Learning Research*, 7:2721–2744, December 2006. <http://dl.acm.org/citation.cfm?id=1248547.1248646>. 4 Feb 2013.

- [36] W. J. Li et al. “Fileprints: identifying file types by n-gram analysis”. *Proceedings from the Sixth Annual IEEE SMC Information Assurance Workshop, 2005*, 64–71. June 2005. <http://dx.doi.org/10.1109/IAW.2005.1495935>. 4 Feb 2013.
- [37] A. Matrosov et al. *Stuxnet under the microscope*. Technical report, eset Security, September 2010.
- [38] R. C. Mayer. *Filetype Identification Using Long, Summarized n-Grams*. Master’s thesis, Naval Postgraduate School, Monterey, CA, March 2011. <http://www.dtic.mil/docs/citations/ADA543322>. 4 Feb 2013.
- [39] R. H. McClanahan. “SCADA and IP: is network convergence really here?” *Industry Applications Magazine, IEEE*, 9(2):29–36, March 2003. <http://dx.doi.org/10.1109/MIA.2003.1180947>. 4 Feb 2013.
- [40] M. McDaniel and M. H. Heydari. “Content Based File Type Detection Algorithms”. *Proceedings of the 36th Annual Hawaii International Conference on System Sciences*. IEEE, January 2003. <http://ieeexplore.ieee.org/xpl/login.jsp?&arnumber=1174905>. 4 Feb 2013.
- [41] L. R. McMinn. *External Verification of SCADA System Embedded Controller Firmware*. Master’s thesis, Air Force Inst of Tech, Wright-Patterson AFB, OH, Graduate School of Engineering and Management, March 2012. <http://oai.dtic.mil/oai/oai?verb=getRecord&metadataPrefix=html&identifier=ADA557800>. 4 Feb 2013.
- [42] “Melissa virus creator jailed”. *BBC Americas*, 2 May 2002. <http://news.bbc.co.uk/2/hi/americas/1963371.stm>. 4 Feb 2013.
- [43] C. Miller. *Battery Firmware Hacking: Inside the innards of a Smart Battery*. Technical report, Accuvant Labs, July 2011.
- [44] S. J. Moody and R. F. Erbacher. “SÁDI-statistical analysis for data type identification”. *Systematic Approaches to Digital Forensic Engineering, 2008. SADFE’08. Third International Workshop on*, 41–54. IEEE, 2008.
- [45] NewMedia-NET. “dd-wrt — Unleash your Router”, January 2013. <http://www.dd-wrt.com/site/index>. 4 Feb 2013.
- [46] A. Pal and N. Memon. “The evolution of file carving”. *Signal Processing Magazine, IEEE*, 26(2):59–71, March 2009. <http://dx.doi.org/10.1109/MSP.2008.931081>. 4 Feb 2013.
- [47] I. Pavlov. “7-Zip”, October 2012. <http://www.7-zip.org/>. 4 Feb 2013.
- [48] D. Peck and D. Peterson. “Leveraging Ethernet Card Vulnerabilities in Field Devices”. *SCADA Security Scientific Symposium*, 1–19. Digital Bond, 2009.

- [49] J. Platt. “Fast training of support vector machines using sequential minimal optimization”. B. Schölkopf, C.J.C. Burges, and A.J. Smola (editors), *Advances in Kernel Methods—Support Vector Learning*. MIT Press, August 1998.
- [50] Python Software Foundation. “random — Generate pseudo-random numbers”, January 2013. <http://docs.python.org/3.3/library/random.html>. 4 Feb 2013.
- [51] J. R. Quinlan. *C4.5: Programs for machine learning*. Morgan Kaufmann, 1993. <http://bit.ly/WpUp5n>. 4 Feb 2013.
- [52] G. G. Richard and V. Roussev. “Scalpel: A Frugal, High Performance File Carver”. *Proceedings of the 2005 digital forensics research workshop (DFRWS 2005)*. 2005.
- [53] P. Roberts. “Hacker Says Texas Town Used Three Character Password To Secure Internet Facing SCADA System”. *ThreatPost*, November 2011. <http://bit.ly/unkgYg>. 4 Feb 2013.
- [54] Rockwell Automation. “CompactLogix System”, January 2013. <http://www.ab.com/en/epub/catalogs/12762/2181376/2416247/407648/7921736/CompactLogix-Modular-Systems.html>. 4 Feb 2013.
- [55] Rockwell Automation. “Network Resources”, January 2013. <http://www.rockwellautomation.com/support/networks/overview.page>. 4 Feb 2013.
- [56] A. W. Samuel. *Hacktivism and the Future of Political Participation*. Ph.D. thesis, Harvard University, Cambridge MA, September 2004.
- [57] I. Schnell. “bitarray 0.8.0: Efficient arrays of booleans – C extension”, April 2012. <http://pypi.python.org/pypi/bitarray/>. 4 Feb 2013.
- [58] M. D. Schwartz et al. *Control System Devices: Architectures and Supply Channels Overview*. Technical Report SAND2010-5183, Sandia National Laboratories, August 2010.
- [59] Siemens Automation. “SIMATIC WinCC”, June 2012. <http://www.automation.siemens.com/mcms/human-machine-interface/en/visualization-software/scada/simatic-wincc/Pages/Default.aspx>. 4 Feb 2013.
- [60] R. L. Sites et al. “Binary translation”. *Commun. ACM*, 36(2):69–81, February 1993. <http://doi.acm.org/10.1145/151220.151227>. 4 Feb 2013.
- [61] M. Story and R. G. Congalton. “Accuracy assessment - A user’s perspective”. *Photogrammetric Engineering and remote sensing*, 52(3):397–399, March 1986.
- [62] K. Stouffer, J. Falco, and K. Kent. *Guide to Supervisory Control and Data Acquisition (SCADA) and Industrial Control Systems Security*. Technical Report Special Publication 800-82, National Institute of Standards and Technology, September 2006.



- [63] The OpenWrt Developers. “OpenWrt”, November 2012. <https://openwrt.org/>. 4 Feb 2013.
- [64] The Rockbox Crew. “Rockbox - Free Music Player Firmware”, January 2013. <http://www.rockbox.org/>. 4 Feb 2013.
- [65] J. Thilmann. “SCADA Security?” *Mechanical Engineering*, 25–31, June 2012.
- [66] “Under Cyberthreat: Defense Contractors”. *Bloomberg Businessweek*, 6 July 2009. <http://buswk.co/Wn3jif>. 4 Feb 2013.
- [67] W. Underwood. “Grammar-Based Specification and Parsing of Binary File Formats”. *The International Journal of Digital Curation*, 7(1):95–106, March 2012.
- [68] United States Computer Emergency Readiness Team. *ICS-Alert: Control System Internet Accessibility*. Technical Report 10-301-01, October 2010.
- [69] United States Computer Emergency Readiness Team and National Institute of Standards and Technology. *Vulnerability Summary for CVE-2010-2965*. Common Vulnerabilities and Exposures CVE-2010-2965, August 2010. <http://web.nvd.nist.gov/view/vuln/detail?vulnId=CVE-2010-2965>. 4 Feb 2013.
- [70] United States Computer Emergency Readiness Team and National Institute of Standards and Technology. *Vulnerability Summary for CVE-2012-0929*. Common Vulnerabilities and Exposures CVE-2012-0929, January 2012. <http://web.nvd.nist.gov/view/vuln/detail?vulnId=CVE-2012-0929>. 4 Feb 2013.
- [71] United States Computer Emergency Readiness Team and National Institute of Standards and Technology. *Vulnerability Summary for CVE-2012-0931*. Common Vulnerabilities and Exposures CVE-2012-0931, January 2012. <http://web.nvd.nist.gov/view/vuln/detail?vulnId=CVE-2012-0931>. 4 Feb 2013.
- [72] United States Computer Emergency Readiness Team and National Institute of Standards and Technology. *Vulnerability Summary for CVE-2012-4690*. Common Vulnerabilities and Exposures CVE-2012-4690, December 2012. <http://web.nvd.nist.gov/view/vuln/detail?vulnId=CVE-2012-4690>. 4 Feb 2013.
- [73] United States Computer Emergency Readiness Team and National Institute of Standards and Technology. *Vulnerability Summary for CVE-2012-5049*. Common Vulnerabilities and Exposures CVE-2012-5049, September 2012. <http://web.nvd.nist.gov/view/vuln/detail?vulnId=CVE-2012-5049>. 4 Feb 2013.
- [74] C. Veenman. “Statistical Disk Cluster Classification for File Carving”. *Information Assurance and Security, 2007. IAS 2007. Third International Symposium on*, 393–398. IEEE, August 2007. <http://dx.doi.org/10.1109/IAS.2007.75>. 4 Feb 2013.



- [75] R. P. Weicker. “Dhrystone: a synthetic systems programming benchmark”. *Commun. ACM*, 27(10):1013–1030, October 1984. <http://doi.acm.org/10.1145/358274.358283>. 4 Feb 2013.
- [76] Wind River. “Wind River VxWorks”, January 2013. <http://www.windriver.com/products/vxworks.html>. 4 Feb 2013.
- [77] I. Witten and E. Frank. *Data Mining: Practical machine learning tools and techniques*. Morgan Kaufmann, 2005. <http://www.cs.waikato.ac.nz/~ml/weka/>. 4 Feb 2013.
- [78] Y. Yang and J. O. Pedersen. “A Comparative Study on Feature Selection in Text Categorization”. *Proceedings of the Fourteenth International Conference on Machine Learning*, 412–420. Morgan Kaufmann, San Francisco, 1997.
- [79] A. Yasinsac et al. *Software Review and Security Analysis of the ES&S iVotronic 8.0.1.2 Voting Machine Firmware*. Technical report, Florida State University, February 2007. <http://www.electioncenter.org/documents/2007/FinalReportSAITLab.pdf>. 4 Feb 2013.
- [80] L. Zhang and G. B. White. “An Approach to Detect Executable Content for Anomaly Based Network Intrusion Detection”. *Parallel and Distributed Processing Symposium, 2007. IPDPS 2007. IEEE International*, 1–8. March 2007. <http://dx.doi.org/10.1109/IPDPS.2007.370614>. 4 Feb 2013.
- [81] C. Zoulas. “file(1) - Linux Man Page”, October 2008. <http://linux.die.net/man/1/file>. 4 Feb 2013.

# REPORT DOCUMENTATION PAGE

Form Approved  
OMB No. 0704-0188

The public reporting burden for this collection of information is estimated to average 1 hour per response, including the time for reviewing instructions, searching existing data sources, gathering and maintaining the data needed, and completing and reviewing the collection of information. Send comments regarding this burden estimate or any other aspect of this collection of information, including suggestions for reducing this burden to Department of Defense, Washington Headquarters Services, Directorate for Information Operations and Reports (0704-0188), 1215 Jefferson Davis Highway, Suite 1204, Arlington, VA 22202-4302. Respondents should be aware that notwithstanding any other provision of law, no person shall be subject to any penalty for failing to comply with a collection of information if it does not display a currently valid OMB control number. **PLEASE DO NOT RETURN YOUR FORM TO THE ABOVE ADDRESS.**

|   |                             |  |   |   |  |
|---|-----------------------------|--|---|---|--|
| <b>1. REPORT DATE (DD-MM-YYYY)</b><br>21-03-2013  |                             | <b>2. REPORT TYPE</b><br>Master's Thesis |   | <b>3. DATES COVERED (From — To)</b><br>Oct 2011–Mar 2013  |  |
| <b>4. TITLE AND SUBTITLE</b><br><br>File Carving and Malware Identification Algorithms Applied to Firmware Reverse Engineering  |                             |  |   | <b>5a. CONTRACT NUMBER</b>  |  |
|   |                             |  |   | <b>5b. GRANT NUMBER</b>   |  |
|   |                             |  |   | <b>5c. PROGRAM ELEMENT NUMBER</b>   |  |
|   |                             |  |   | <b>5d. PROJECT NUMBER</b>   |  |
|   |                             |  |   | <b>5e. TASK NUMBER</b>  |  |
|   |                             |  |   | <b>5f. WORK UNIT NUMBER</b>   |  |
| <b>6. AUTHOR(S)</b><br><br>Sickendick, Karl A., Captain, USAF   |                             |  |   | <b>8. PERFORMING ORGANIZATION REPORT NUMBER</b><br><br>AFIT-ENG-13-M-46   |  |
| <b>7. PERFORMING ORGANIZATION NAME(S) AND ADDRESS(ES)</b><br>Air Force Institute of Technology<br>Graduate School of Engineering and Management (AFIT/EN)<br>2950 Hobson Way<br>WPAFB, OH 45433-7765  |                             |  |   | <b>9. SPONSORING / MONITORING AGENCY NAME(S) AND ADDRESS(ES)</b><br>Department of Homeland Security ICS-CERT<br>POC: Neil Hershfield, DHS ICS-CERT Technical Lead<br>ATTN: NPPD/CS&C/NCSO/US-CERT<br>Mailstop: 0635, 245 Murray Lane, SW, Bldg 410, Washington DC 20528<br>Email: ics-cert@dhs.gov; Phone: 1-877-776-7585 |  |
|   |                             |  |   | <b>10. SPONSOR/MONITOR'S ACRONYM(S)</b><br>DHS ICS-CERT   |  |
| <b>12. DISTRIBUTION / AVAILABILITY STATEMENT</b><br>DISTRIBUTION STATEMENT A. APPROVED FOR PUBLIC RELEASE; DISTRIBUTION UNLIMITED   |                             |  |   | <b>11. SPONSOR/MONITOR'S REPORT NUMBER(S)</b>   |  |
| <b>13. SUPPLEMENTARY NOTES</b><br>This work is declared a work of the U.S. Government and is not subject to copyright protection in the United States.  |                             |  |   |   |  |
| <b>14. ABSTRACT</b><br>Modern society depends on critical infrastructure (CI) managed by Programmable Logic Controllers (PLCs). PLCs depend on firmware, though firmware security vulnerabilities and contents remain largely unexplored. Attackers are acquiring the knowledge required to construct and install malicious firmware on CI. To the defender, firmware reverse engineering is a critical, but tedious, process. This thesis applies machine learning algorithms, from the file carving and malware identification fields, to firmware reverse engineering. It characterizes the algorithms' performance. This research describes and characterizes a process to speed and simplify PLC firmware analysis. The system partitions binary firmwares into segments, labels each segment with a file type, determines the target architecture of code segments, then disassembles and performs rudimentary analysis on the code segments. The research discusses the system's accuracy on a set of pseudo-firmwares. Of the algorithms this research considers, a combination of a byte-value frequency file carving algorithm and a support vector machine (SVM) algorithm using information gain (IG) for feature selection achieve the best performance. That combination correctly identifies the file types of 57.4% of non-code bytes, and the architectures of 85.3% of code bytes. This research applies the Firmware Disassembly System to a real-world firmware and discusses the contents. |                             |  |   |   |  |
| <b>15. SUBJECT TERMS</b><br>Control systems, firmware, reverse engineering, programmable logic controller (PLC)   |                             |  |   |   |  |
| <b>16. SECURITY CLASSIFICATION OF:</b>  |                             |  | <b>17. LIMITATION OF ABSTRACT</b><br><br>UU | <b>18. NUMBER OF PAGES</b><br><br>137   | <b>19a. NAME OF RESPONSIBLE PERSON</b><br>Thomas, E. Dube, Maj, USAF         |
| <b>a. REPORT</b><br><br>U   | <b>b. ABSTRACT</b><br><br>U | <b>c. THIS PAGE</b><br><br>U             |   |   | <b>19b. TELEPHONE NUMBER (include area code)</b><br>(937) 255-3636 ext. 4613 |